

TC-177SD

AEP Model
E Model
UK Model
USA Model



STEREO CASSETTE-CORDER

SPECIFICATIONS

Power Requirements:	AC 120 V, 60 Hz (USA Model) 240 V, 50 Hz (UK Model) 110, 127, 220, 240 V, 50/60 Hz (AEP Model) 100, 110, 120, 127, 220, 240 V, 50/60 Hz (E Model)	Inputs:	MICROPHONE 2 for low impedance microphone Maximum sensitivity: -72 dB (0.19 mV) LINE IN 2 Impedance: 100 k Ω Maximum sensitivity: -22 dB (62 mV) LINE OUT 2 Impedance: more than 10 k Ω Normal level: 0 dB (0.775 V) with 100 k Ω load (LINE OUT maximum)
Power Consumption:	52 W (AEP, E and UK Models) 45 W (USA Model)	Outputs:	HEADPHONE 1 Impedance: 8 Ω Normal level: LEVEL 1 -30 dB (25 mV) LEVEL 2 -22 dB (62 mV)
Track System:	4 track, 2 channel stereo	Semiconductors:	55 transistors, 46 diodes, 11 IC's 1 Hall IC, and 2 FET's
Tape:	SONY tape cassette or equivalent	Record Head:	PF155-6102
Tape Speed:	4.8 cm/s (1 $\frac{7}{8}$ ips)	Playback Head:	PF145-3602B
Recording Time: (with C-120 tape cassette)	2 hrs	Erase Head:	EF157-36
Frequency Response:	NORMAL: 20 ~ 17,000 Hz (NAB) 30 ~ 15,000 Hz (DIN) Fe-Cr, CrO ₂ : 20 ~ 20,000 Hz (NAB) 30 ~ 18,000 Hz (DIN)	Motor:	HC-526 (6-pole hysteresis-synchronous)
Wow and Flutter:	0.08 % (RMS) weighted (NAB) \pm 0.2 % (DIN)	Dimensions:	435 (w) x 155 (h) x 325 (d) mm 17 $\frac{1}{8}$ (w) x 6 $\frac{1}{8}$ (h) x 12 $\frac{7}{8}$ (d) inches
Overall Signal-to-Noise Ratio:	DOLBY* NR OFF: 53 dB (NORMAL) 55 dB (Fe-Cr, CrO ₂) DOLBY* NR ON: improved 5 dB at 1 kHz, 10 dB above 5 kHz	Weight:	10 kg, 22 lb 1 oz
Overall Distortion:	2 % (CS-10, CS-20, CS-30 tapes) (UK Model) 1.3 % (AEP, E and USA Models)		
Record Bias Frequency:	105 kHz		

* The word Dolby is the trademark of
Dolby Laboratories, Inc.

SONY
SERVICE MANUAL

TABLE OF CONTENTS

<u>Section</u>	<u>Title</u>	<u>Page</u>
	Specifications	1
1. OUTLINE		
1-1.	Block Diagram	3
1-2.	External View (1)	5
1-3.	External View (2)	5
1-4.	Internal View (1)	6
1-5.	Internal View (2)	6
1-6.	Internal View (3)	7
2. DISASSEMBLY		
2-1.	Cassette Lid Ass'y Removal	7
2-2.	Case Removal	8
3. ADJUSTMENTS		
3-1.	Mechanical Adjustment (1)	9
3-2.	Mechanical Adjustment (2)	11
3-3.	Electrical Adjustments and Measurements	13
4. DIAGRAMS		
4-1.	Level Diagrams	26
4-2.	Schematic Diagram (1)	27
4-3.	Mounting Diagram (1)	29
4-4.	Mounting Diagram (2)	32
4-5.	Schematic Diagram (2)	35
5. EXPLODED VIEWS AND PACKING		37
6. ELECTRICAL PARTS LIST		50
7. HARDWARE		56

*When ordering replacement parts, use PART NUMBERS listed in Parts Lists or shown in EXPLODED VIEWS.
Parts List reference numbers should not be used.*

CAUTION

1. Record and playback level adjustments should be carefully made. The levels must be as specified for correct DOLBY circuit operation.
2. When replacing resistors and capacitors needing $\pm 2\%$ tolerance, use only those with red line or G mark, as DOLBY system requires precise circuit operation.

$\pm 2\%$ Tolerance Identification

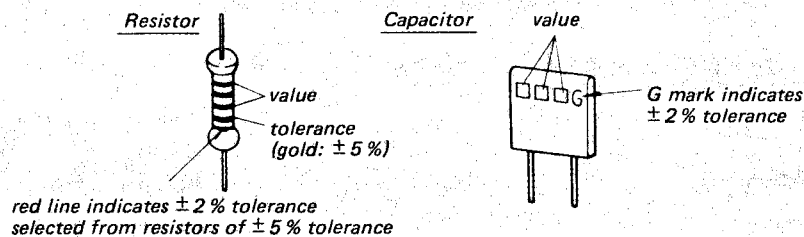

SECTION 1
OUTLINE

1-1. BLOCK DIAGRAM

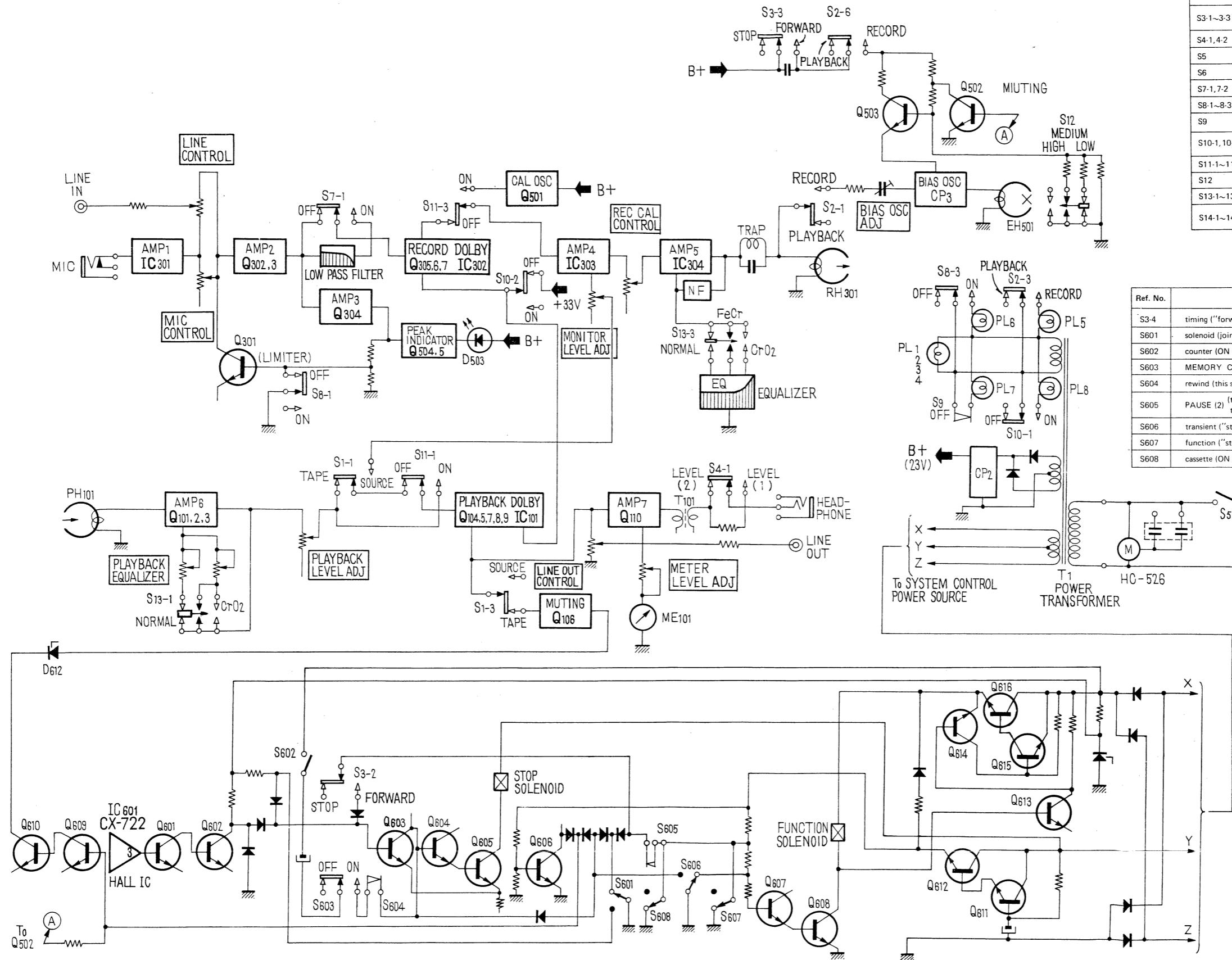

Ref. No.	Switch	Mode
S1-1~1-4	MONITOR (SOURCE/TAPE)	TAPE
S2-1~2-6	record/playback	playback
S3-1~3-3	timing ("forward" in playback/"stop" in the other modes. / "stop" in the other modes.)	stop
S4-1,4-2	HEADPHONE LEVEL (1/2)	2
S5	POWER (ON/OFF)	OFF
S6		
S7-1,7-2	FILTER (ON/OFF)	OFF
S8-1~8-3	LIMITER (ON/OFF)	OFF
S9	PAUSE (1) (ON/OFF)	OFF
S10-1,10-2	DOLBY NR (ON/OFF)	OFF (OFF button is depressed.)
S11-1~11-4	CAL TONE (ON/OFF)	OFF
S12	BIAS (LOW/MEDIUM/HIGH)	LOW
S13-1~13-4	EQ (NORMAL/Fe-Cr/CrO2)	NORMAL
S14-1~14-4	FM DOLBY NR (ON/OFF)	OFF (OFF button is depressed.)

Ref. No.	Switch	Mode
S3-4	timing ("forward" in playback and record modes/"stop" in the other modes.)	stop
S601	solenoid (jointed with the function solenoid, "stop" in stop mode/ON in the other modes.)	stop
S602	counter (ON at "000" indication/OFF at the other indications)	OFF
S603	MEMORY COUNTER (ON/OFF)	OFF
S604	rewind (this switch turns ON only when the rewind button is depressed.)	OFF
S605	PAUSE (2) (this switch turns ON to prevent the stop solenoid operation when the PAUSE button is depressed in playback or record mode.)	OFF
S606	transient ("stable" in stop mode/momentary ON in the other modes.)	stable
S607	function ("stop" in stop mode/ON in the other modes.)	stop
S608	cassette (ON when the tape cassette is inserted.)	OFF

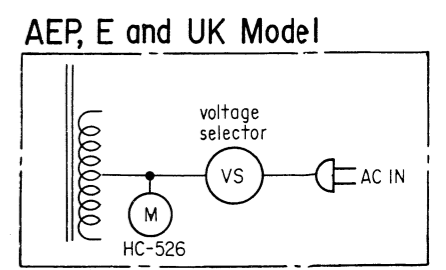

1-2. EXTERNAL VIEW (1)

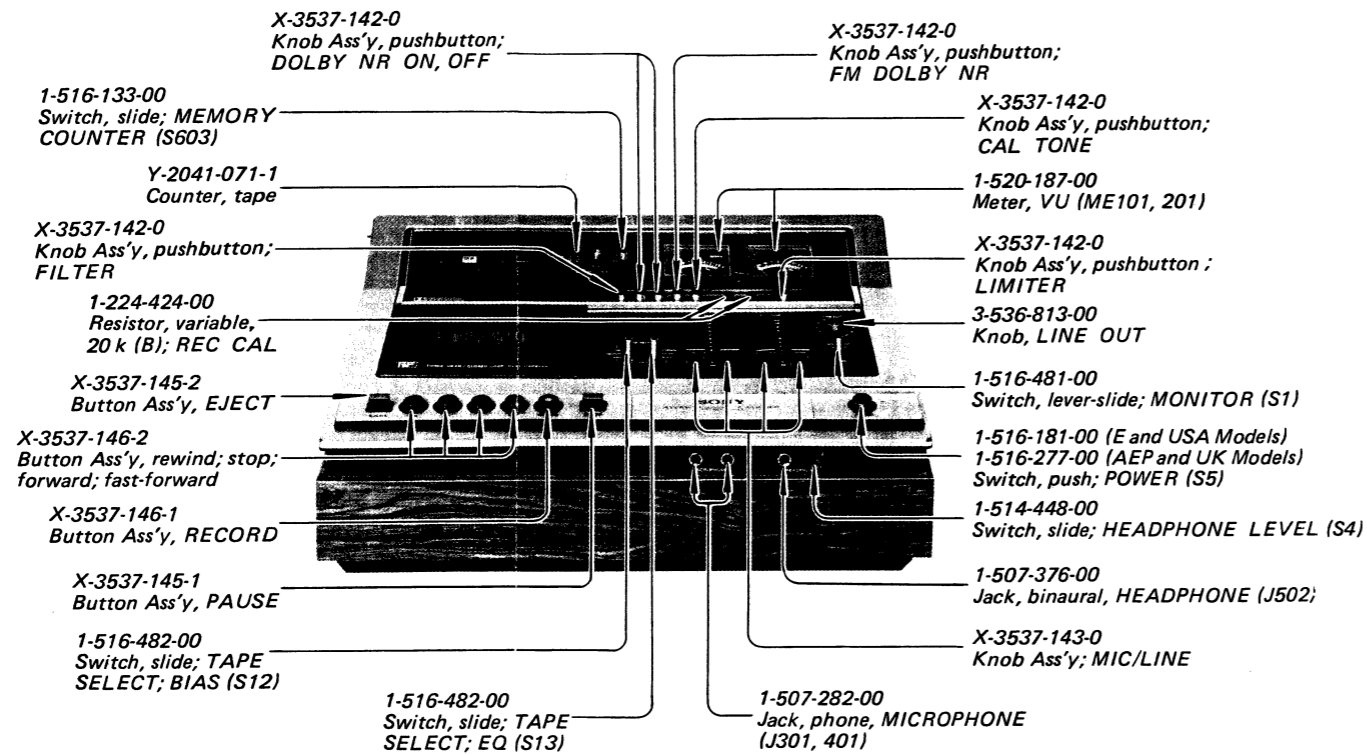

1-3. EXTERNAL VIEW (2)

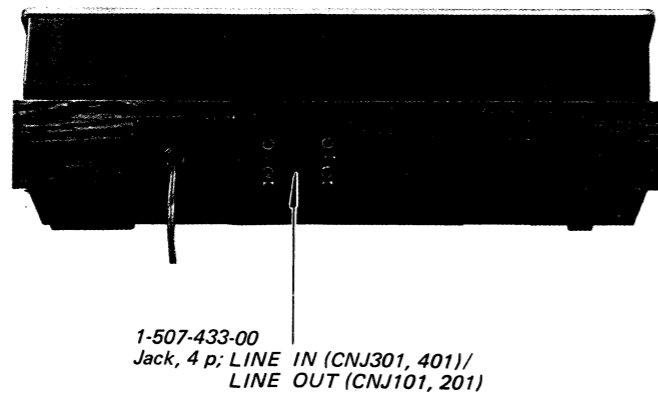

Note: USA Model is shown.

1-4. INTERNAL VIEW (1)

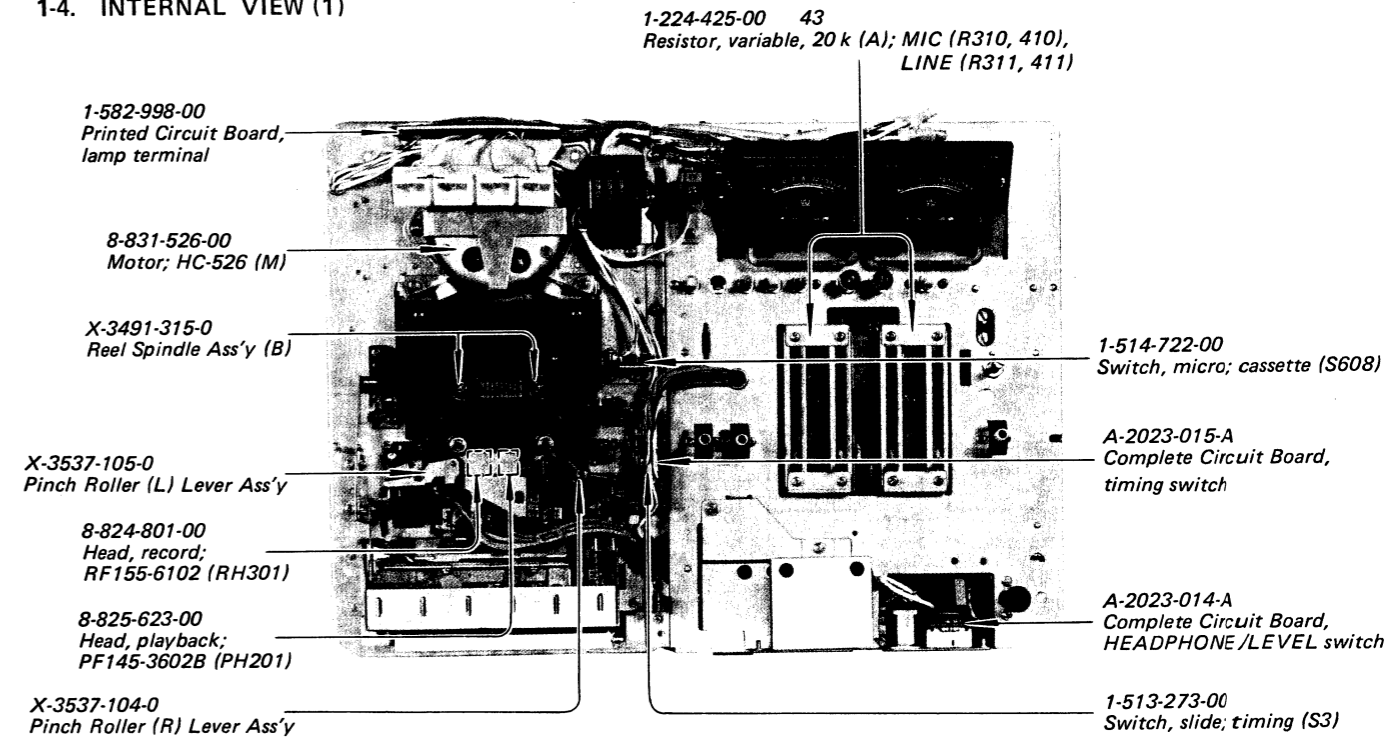

1-5. INTERNAL VIEW (2)

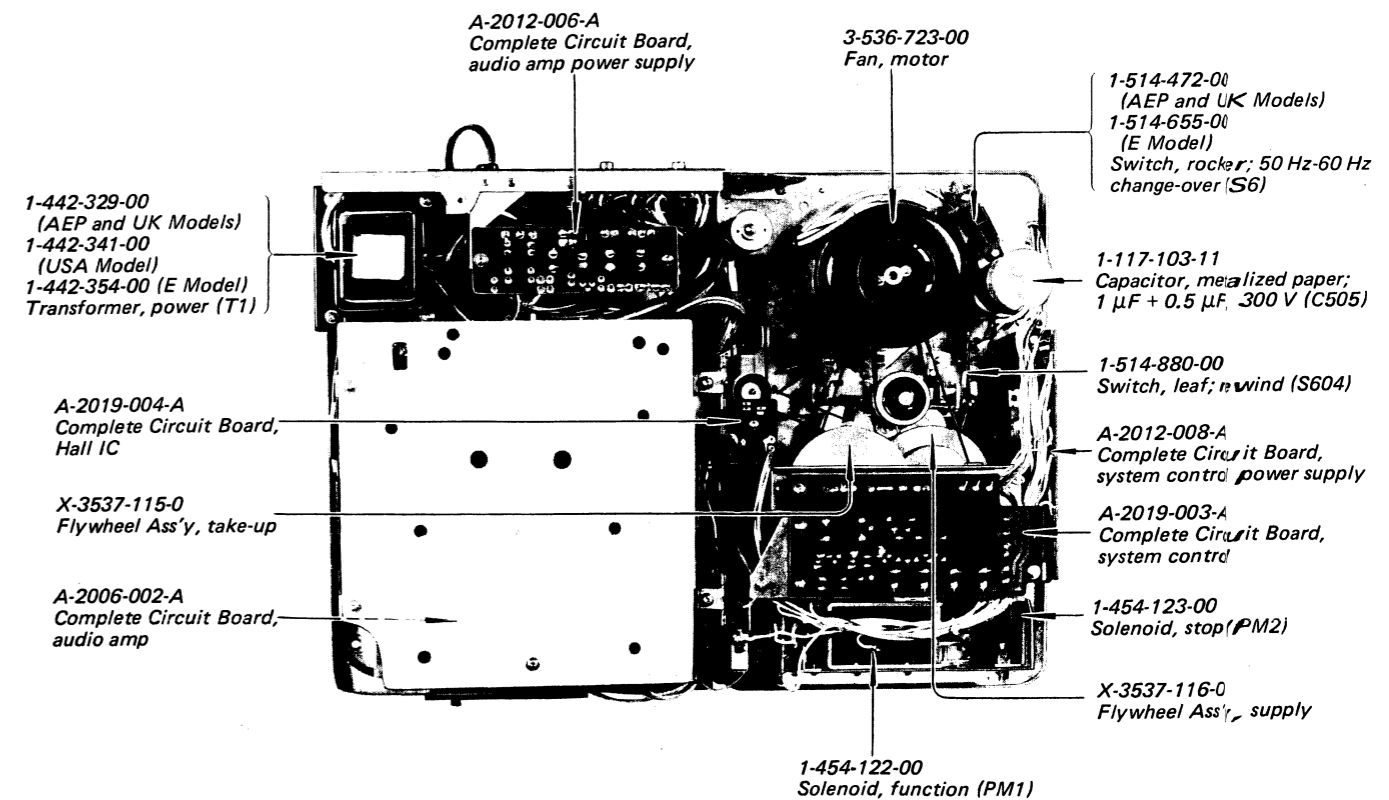

1.6. INTERNAL VIEW (3)

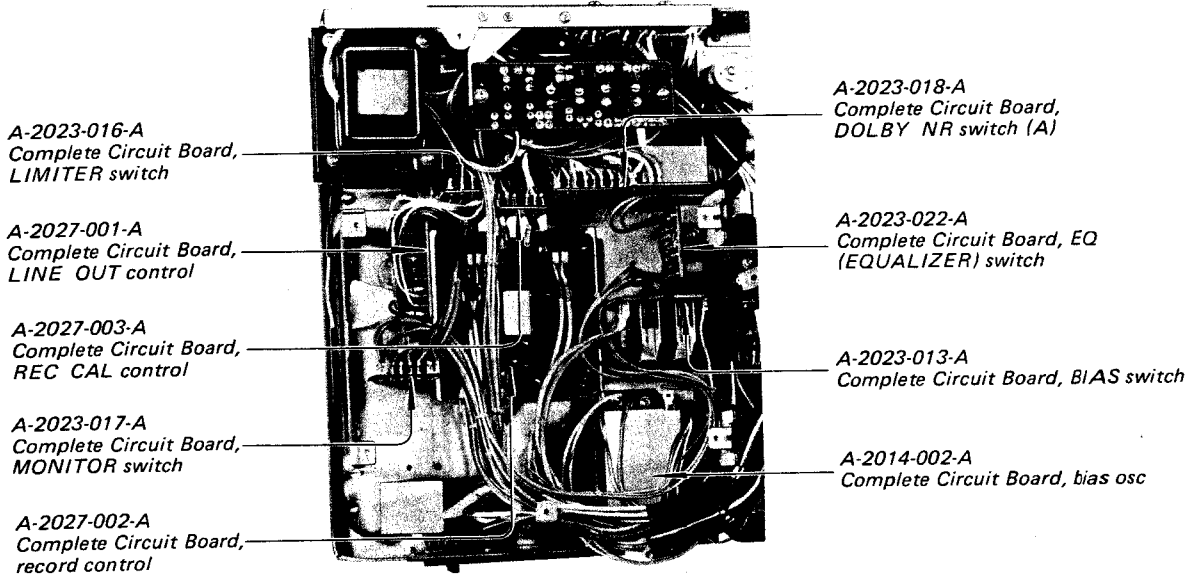

Note: Audio amp circuit board is turned out.

**SECTION 2
DISASSEMBLY**

2.1. CASSETTE LID ASS'Y REMOVAL

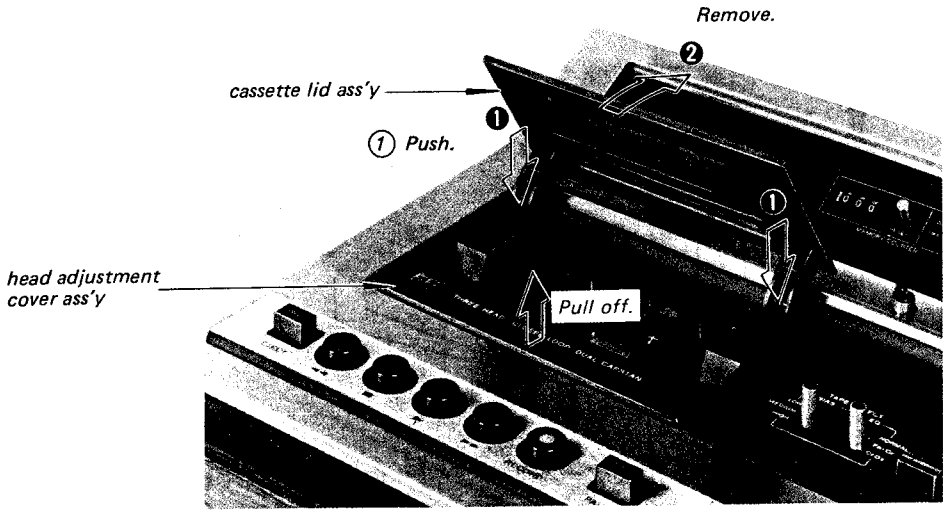

Note: Head azimuth adjustments can be made by pulling off the head adjustment cover ass'y and pressing the forward button.

2-2. CASE REMOVAL

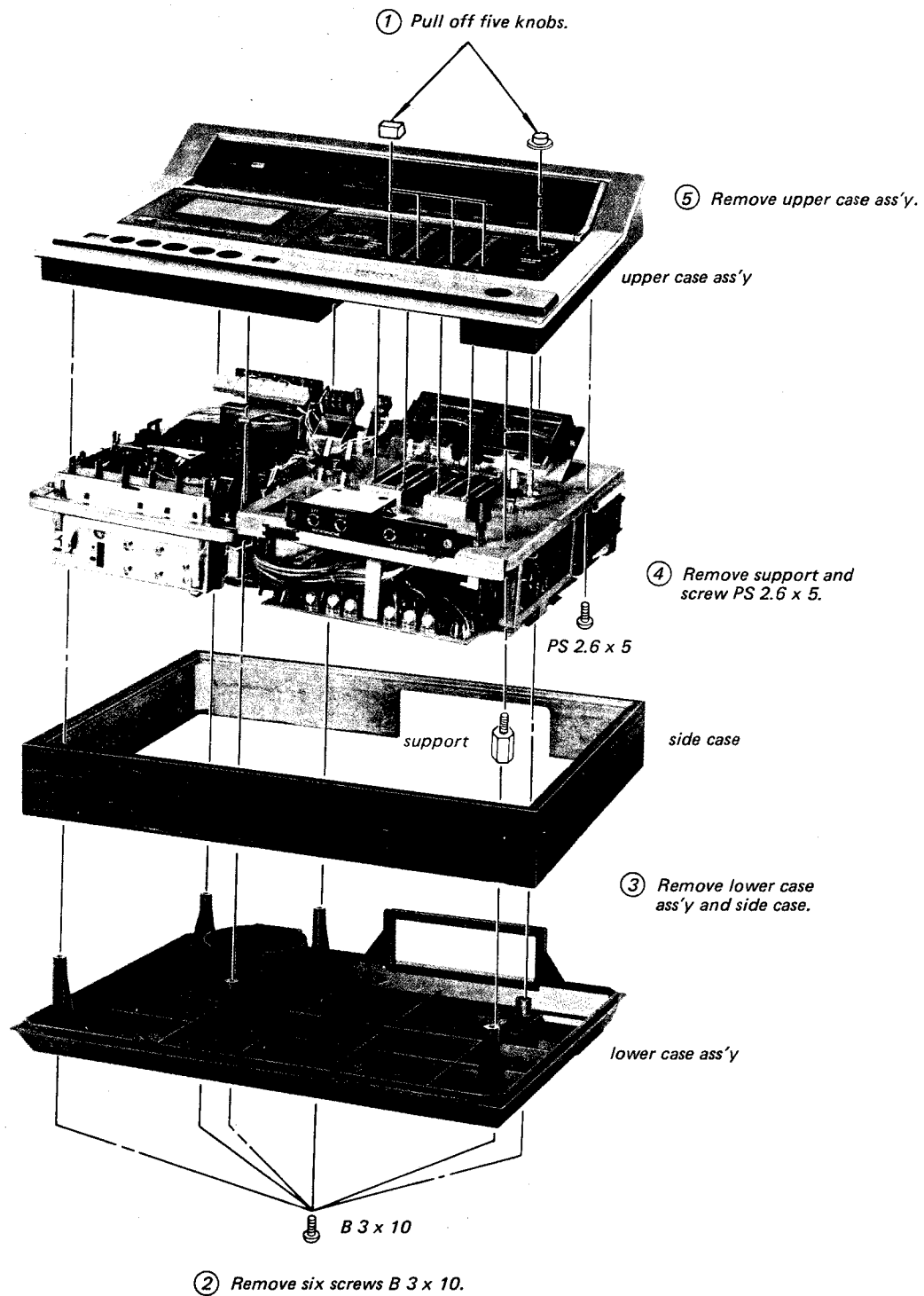

SECTION 3
ADJUSTMENTS

3-1. MECHANICAL ADJUSTMENT (1)

Tape Path Adjustment

1. Prepare an adjustment cassette for this adjustment as follows.

Tape cassette: SONY C-120

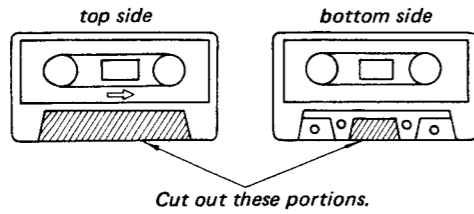

2. Erase Head Height Adjustment:

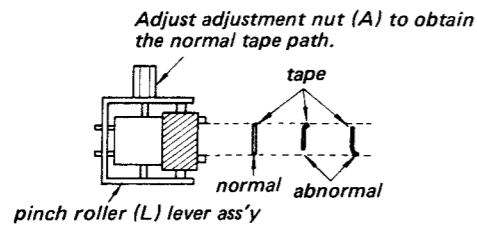

3. Tape Guide Height Adjustment:

Adjust adjustment nuts (A) and (B) to obtain the normal tape path.

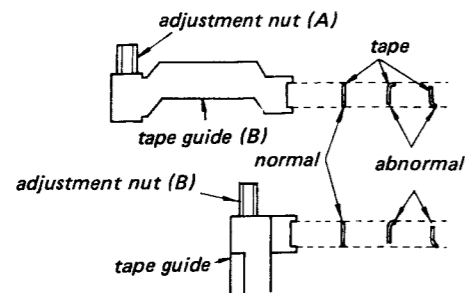

4. Playback Head Height Adjustment

1) Adjust three adjustment screws to make the bottom edge of the core flush with the bottom edge of the tape.

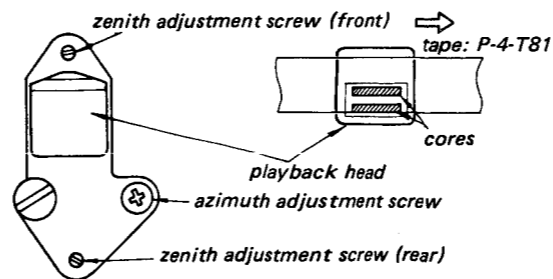

2) Mode: Playback
Tape: P-4-T81

Adjust three screws to obtain maximum LINE OUT voltage.

5. Record Head Height Adjustment

Adjust three adjustment screws to obtain maximum LINE OUT voltage by repeating record and playback alternately.

Note: When replacing the record head, remove the screw PS 2 x 5 and washer W2 only. Do not touch the other screws.

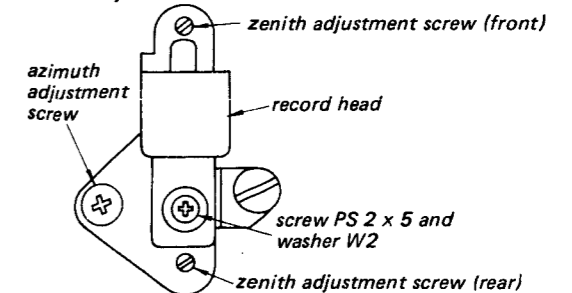

Pinch Roller Pressure Measurement
— Playback mode —

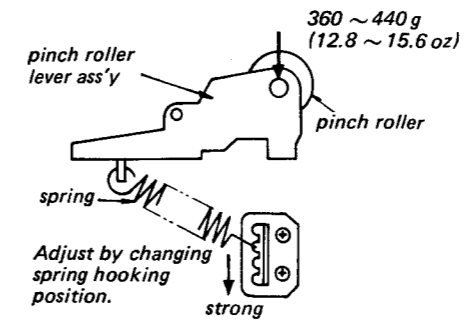

Note: Perform measurement for both pinch roller (L) lever ass'y and pinch roller (R) lever ass'y.

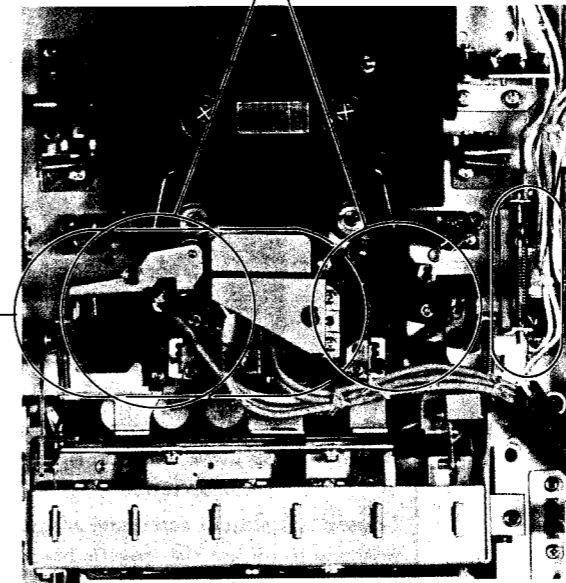

Timing Switch Position Adjustment
— Stop mode —

Loosen two screws, PS 2.6 x 5.

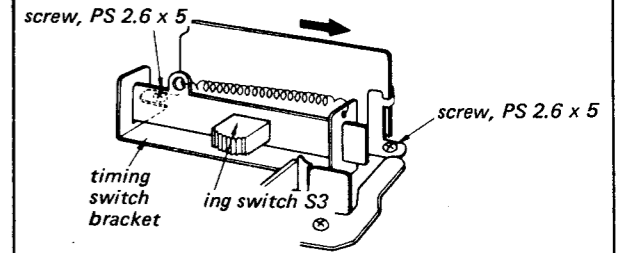

— Playback mode —

Move the timing switch bracket in the direction shown by the arrow until the switch knob just contacts the switch frame.

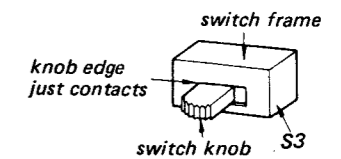

Note: Do not move the timing switch bracket excessively. Otherwise, tape touch might be degraded.
After adjustment, assure that the switch turns before the forward button locks.

3-2. MECHANICAL ADJUSTMENT (2)

Forward Torque Adjustment
— Playback mode —

Adjust reel spindle clutch spring position to obtain the specified value.
If necessary, adjust clutch-wheel ass'y position by loosening set screw.

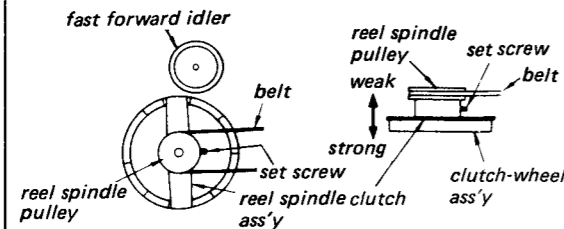

Specification: 45 ~ 60 g.cm
(0.63 ~ 0.83 oz.-inch)

Fast Forward and Rewind Torque Adjustment

— Fast Forward mode —
— Rewind mode —

Adjust fast forward pulley position by loosening screw to obtain the specified values.
If necessary, adjust pulley spring position.

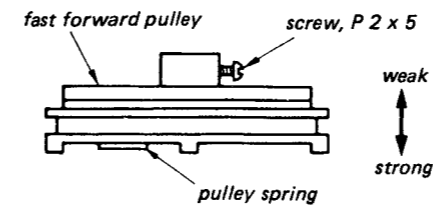

Specification:
Fast Forward mode: 70 g.cm (0.97 oz.-inch)
Rewind mode: 80 g.cm (1.11 oz.-inch)

Rewind Leaf Switch (S604) Position Adjustment

— Stop mode —

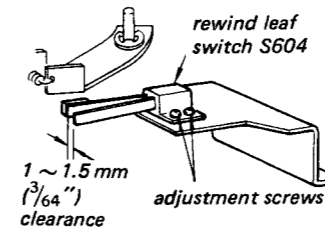

— Rewind mode —

Loosen adjustment screws and adjust switch position so that the edge of leaf bends 4 ~ 6 mm (5/32 ~ 1/4 inch) until rewind button is locked after the switch contacts have been just closed.

PAUSE (2) Leaf Switch (S605) Position Adjustment

By pressing the PAUSE button, loosen adjustment screws and adjust switch position so that the switch contacts are closed just when the clearance does not exist. Switch leaf edge should bend more than 4 mm (5/32 inch) when the PAUSE button locks.

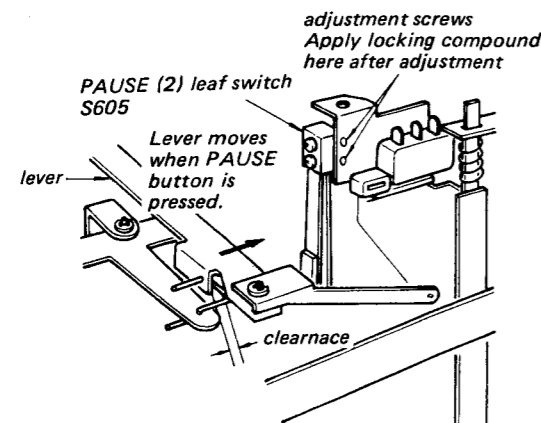

Note: Photograph is the USA Model.

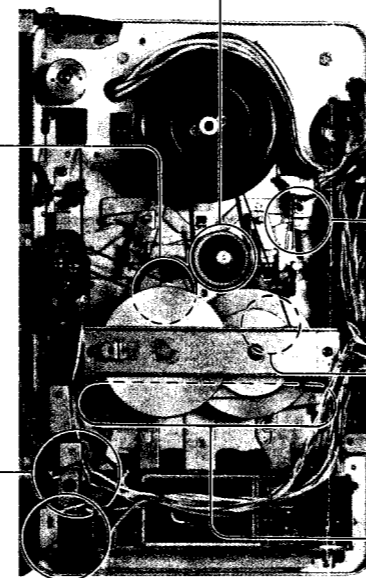

Pause Release Lever Position Adjustment

— Stop mode —

Loosen adjustment screw and adjust pause release lever position to obtain the specified clearance.

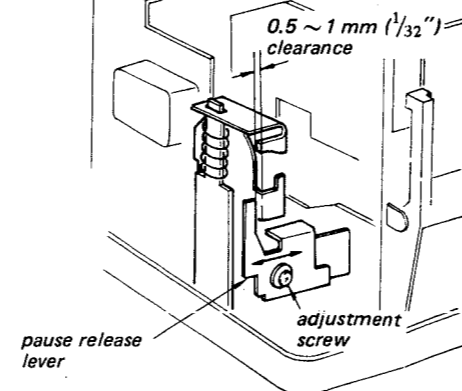

After adjustment, assure that the stop button releases locked PAUSE button. Apply locking compound to adjustment screw after adjustment.

PAUSE Timing Adjustment

— Playback mode
(cassette switch
S608 ON) —

Adjust by bending the specified portions of pause function plates (L) and (R) to obtain proper timing. Gradually press the PAUSE button, and take-up reel spindle should cease rotating after left-side and right-side pinch rollers released. Left-side and right-side pinch rollers should release at the same time or left-side pinch roller should release faster.

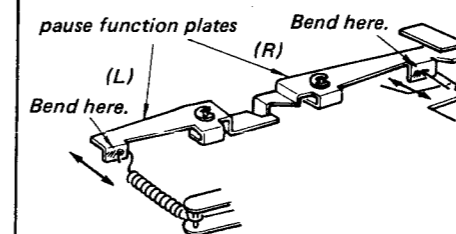

Back Tension Torque Adjustment
— Playback and PAUSE modes —

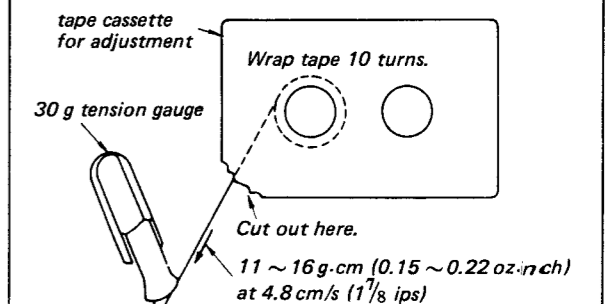

Unplug power cord and adjust spring hooking position to obtain the specified value.

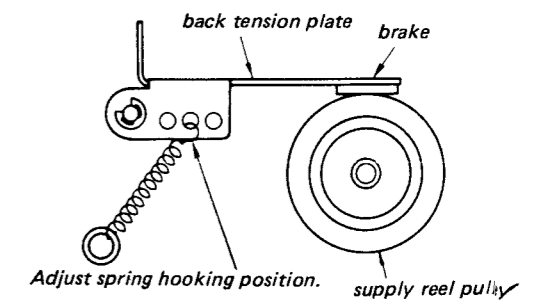

3.3. ELECTRICAL ADJUSTMENTS AND MEASUREMENTS

PRECAUTION

1. Clean the following parts with an alcohol moistened swab:
 - * record and playback heads
 - * pinch rollers
 - * erase head
 - * rubber belts
 - * capstans
 - * idlers
2. Demagnetize record and playback heads with a head demagnetizer.
3. Do not use magnetized screwdriver for adjustments.
4. After adjustments, apply a small amount of locking compound to the parts adjusted.
5. Adjustments should be performed in the order arranged in this service manual.
6. Adjustments and measurements should be performed for both L-CH and R-CH with rated power supply voltage unless otherwise specified.
7. Record and playback level adjustments should be carefully performed.

Test Equipment/Tools Required:

- audio oscillator (af osc)
- VTVM
- digital frequency counter
- speed checker SONY LMF-30
- oscilloscope
- bandpass filters (400 Hz, 1 kHz, 10 kHz)
- attenuator (600 Ω)
- non-magnetic screwdriver
- resistors . . . 6 Ω (¼ W), 8 Ω (¼ W), 300 Ω (¼ W), 594 Ω (¼ W, 600 Ω and 60 kΩ in parallel), 600 Ω (¼ W), 10 kΩ (¼ W), 80 kΩ (¼ W), 100 kΩ (¼ W)
- blank tapes (completely erased with bulk eraser)
 - SONY CS-10 (HF), CS-20 (CrO₂), CS-30 (Fe-Cr)

BIAS and EQ switch settings in accordance with tape used are as follows.

Tape	BIAS switch	EQ switch
CS-10	LOW	NORMAL
CS-20	HIGH	CrO ₂
CS-30	LOW	Fe-Cr

SONY test tapes

- P-4-A81S (6.3 kHz, -10 dB)
- P-4-A82 (10 kHz, -10 dB)
- P-4-L81 (333 Hz, 0 dB)
- SPC-4 (1 kHz, 0 dB)

Switches and controls should be set as follows unless otherwise specified.

- FILTER switch: OFF
- FM DOLBY NR switch: OFF
- DOLBY NR switch: OFF
- CAL TONE switch: OFF
- REC CAL control: mechanical mid
- LIMITER switch: OFF
- LINE OUT control: MAX
- MONITOR switch: (SOURCE (record mode)
TAPE (playback mode))
- LINE/MIC controls: MIN
- EQ switch: NORMAL
- BIAS switch: LOW
- TAPE SELECT EQ switch: NORMAL

Test Equipment Connections:

Input side:

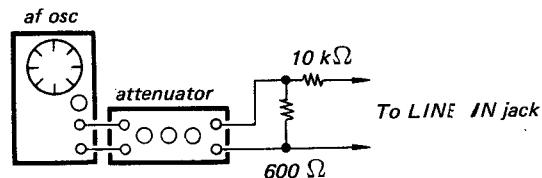
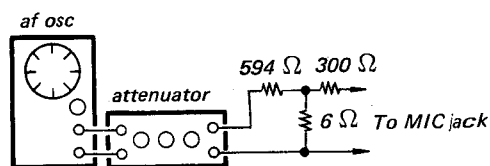

Standard Record:

Deliver the specified input signal level to the input jack and set the MIC or LINE control to obtain the specified output signal level. Set the LINE control to MIN when MIC IN is used or set MIC control to MIN when LINE IN is used.

Standard Input Level

	MIC IN	LINE IN
source impedance	300 Ω	10 kΩ
input level	-60 dB (0.77 mV)	-10 dB (0.3 V)

Standard Output Level

	LINE OUT	HEADPHONE
load impedance	100 kΩ	8 Ω
output level	0 dB (0.775 V)	LEVEL 1: -32 dB (19 mV) LEVEL 2: -22 dB (2 mV)

1. Monitor Level Adjustment

Procedure:

1. Mode: Standard record (See page 13.)

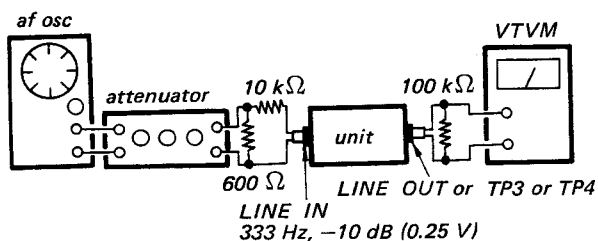

2. Adjust LINE control to obtain 0 dB (0.775 V) at TP3 and TP4.
3. Adjust R361 (L-CH) and R461 (R-CH) to obtain 0 dB (0.775 V) at LINE OUT.

Specification:

Level difference between channels:
less than 0.5 dB

Adjustment Location:

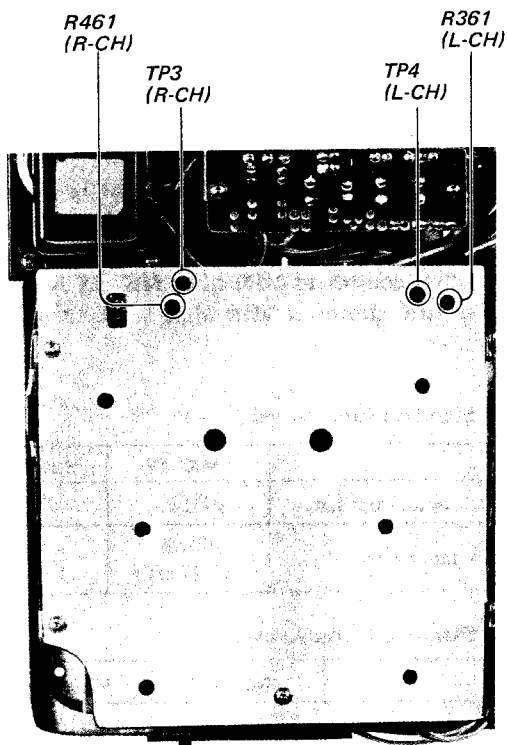

2. Record DOLBY Adjustment

Procedure:

1. Mode: Standard record (See page 13.)

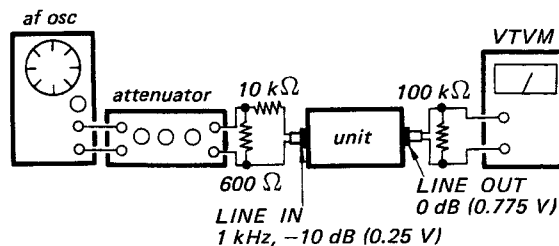

2. Mode: Record
DOLBY NR switch: ON and OFF

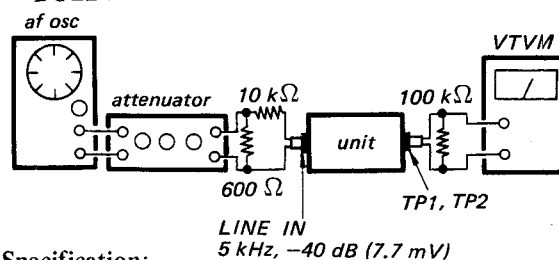

Specification:

DOLBY NR switch	VTVM reading difference
ON	8 dB ± 0.5 dB
OFF	

Level difference between channels:
less than 0.5 dB

If necessary, adjust R347 (L-CH) and R447 (R-CH) to obtain the specified value.

Adjustment Location:

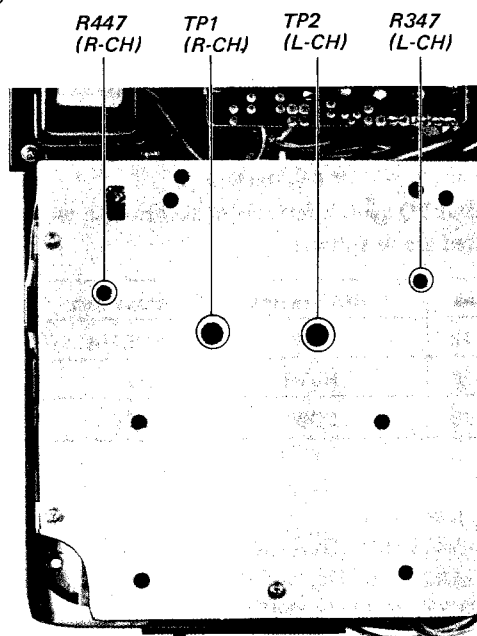

3. Playback DOLBY Adjustment

Procedure:

1. Mode: Standard record (See page 13.)

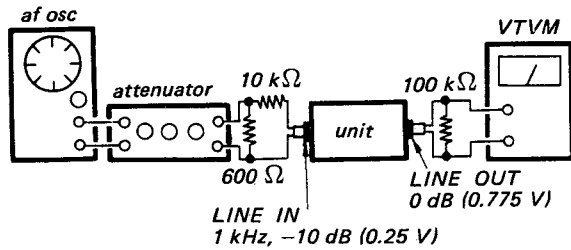

2. Mode: Record
DOLBY NR switch: ON

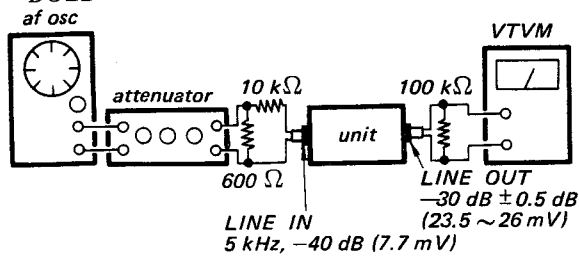

Adjust R147 (L-CH) and R247 (R-CH) to obtain the specified value.

Specification:

- LINE OUT level: $-30 \text{ dB} \pm 0.5 \text{ dB}$ (23.5 ~ 26 mV)
- Level difference between channels: less than 0.5 dB

Adjustment Location:

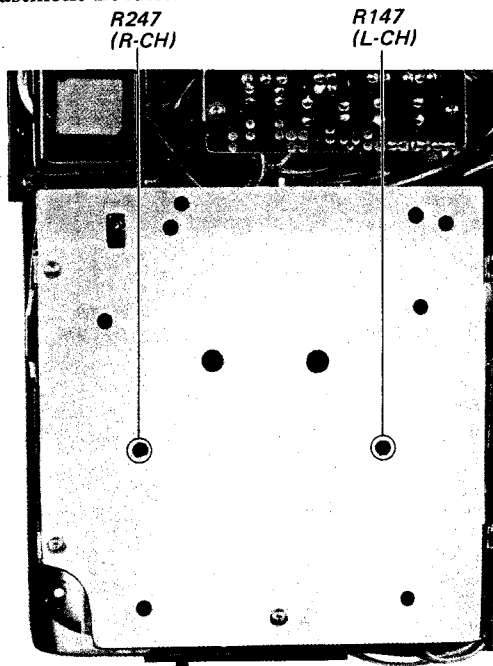

4. CAL TONE Level Adjustment and Osc Frequency Check

Procedure:

1. CAL TONE switch: ON

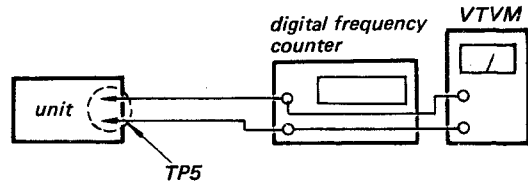

2. Adjust R523 to obtain $-37 \text{ dB} \pm 0.3 \text{ dB}$ (10.5 ~ 11.3 mV) VTVM reading.
3. Digital frequency counter reading should be 370 Hz ~ 430 Hz.

Adjustment Location:

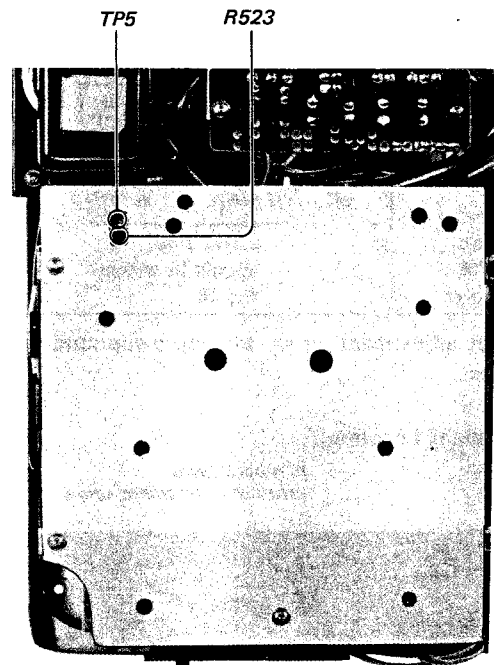

5. Playback Head Azimuth Adjustment

Procedure:

- Mode: Playback
MONITOR switch: TAPE

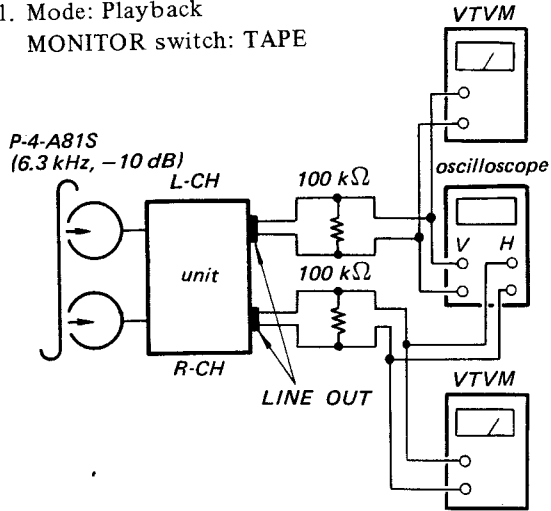

2.

Adjust	Oscilloscope patterns
azimuth adjustment screw to obtain the in-phase pattern around the highest VTVM readings.	<p>[Allowance]</p> <p><i>in-phase</i></p> <p><i>90° out-of-phase</i></p> <p>Level drop should be within 0.5 dB</p>

- After adjustment, apply locking compound to the screw.

Adjustment Location:

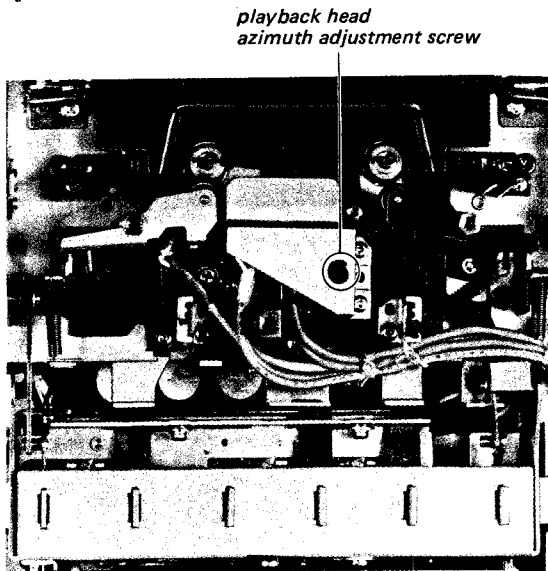

6. Playback Level Adjustment

Procedure:

- Mode: Playback
MONITOR switch: TAPE

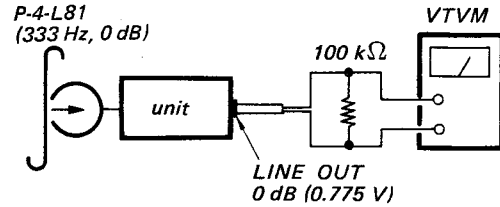

Adjust R118 (L-CH) and R218 (R-CH) to obtain 0 dB (0.775 V) VTVM reading.

- Assure that the LINE OUT level does not change when the mode is changed from playback to stop several times.

Specification:

LINE OUT level: 0 dB \pm 0.5 dB
(0.74 ~ 0.82 V)

Level difference between channels:
less than 0.5 dB

Adjustment Location:

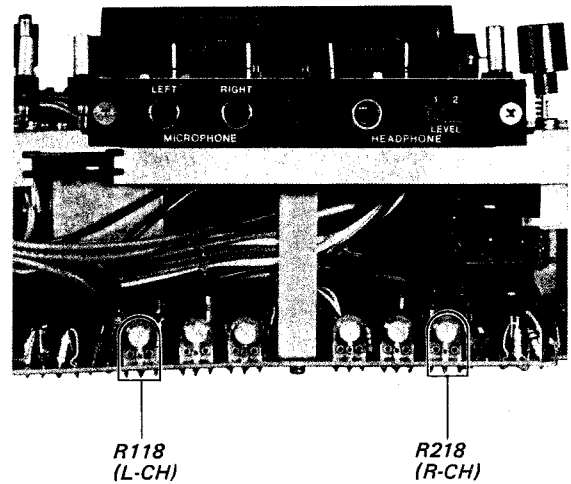

7. Playback Equalizer Adjustment

Procedure:

1. Mode: Playback

MONITOR switch: TAPE

P-4-L81
(333 Hz, 0 dB)

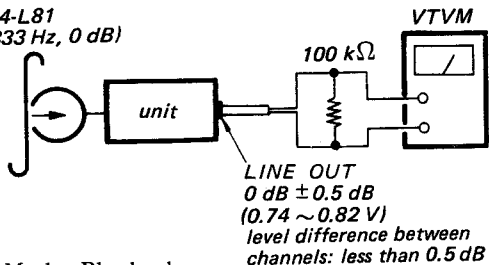

2. Mode: Playback

P-4-A81S
(6.3 kHz, -10 dB)

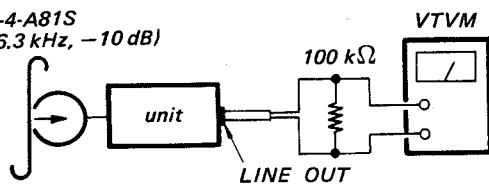

1) TAPE SELECT EQ switch: Fe-Cr

Adjust R115 (L-CH) and R215 (R-CH) to obtain the LINE OUT voltage 16.0 dB lower than that obtained in step 1 above.

Specification: 15.5 ~ 16.5 dB lower

2) TAPE SELECT EQ switch: NORMAL

Adjust R116 (L-CH) and R216 (R-CH) to obtain the LINE OUT voltage 11.5 dB lower than that obtained in step 1 above.

Specification: 11.0 ~ 12 dB lower

3. Mode: Playback

P-4-A82
(10 kHz, -10 dB)

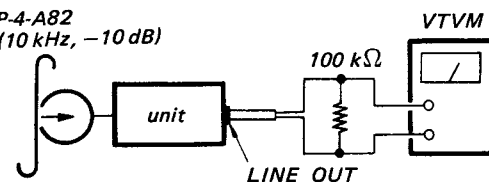

TAPE SELECT EQ switch: NORMAL

Assure that the LINE OUT voltage is 11.5 dB lower than that obtained in step 1 above.

Specification: 13.5 ~ 9.5 dB lower

level difference between channels:
less than 2 dB

Adjustment Location:

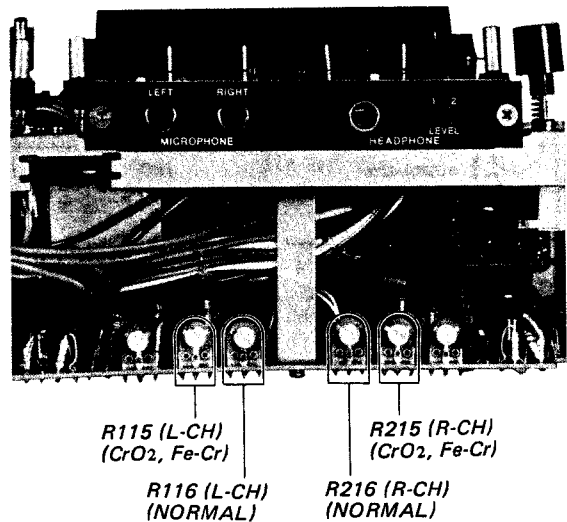

8. Playback Signal-to-Noise Ratio Measurement

Procedure:

1. Mode: Playback

MONITOR switch: TAPE

P-4-L81
(333 Hz, 0 dB)

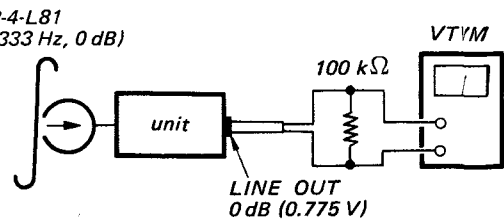

2. Mode: Playback

PAUSE button: pressed

TAPE SELECT EQ switch: NORMAL, CrO₂ or Fe-Cr

Measure noise level at LINE OUT.

Specification:

TAPE SELECT EQ switch	Signal-to-Noise Ratio
NORMAL	More than 49.0 dB
CrO ₂ Fe-Cr	More than 51.0 dB

9. VU Meter Calibration

Procedure:

1. Mode: Standard record (See page 13.)

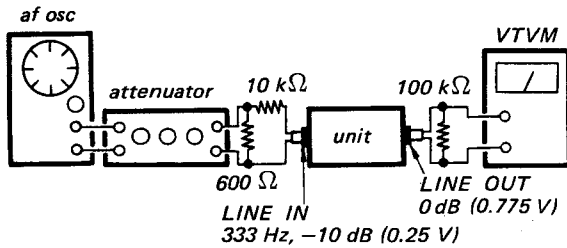

- 2.

Adjust	VU meter reading: 0 VU
R163 (L-CH)	
R263 (R-CH)	

Specification:

When the LINE IN level is adjusted to make 0 VU indication, VTVM reading should be $-0.5 \sim +0.5$ dB (0.74 ~ 0.82 V)

Adjustment Location:

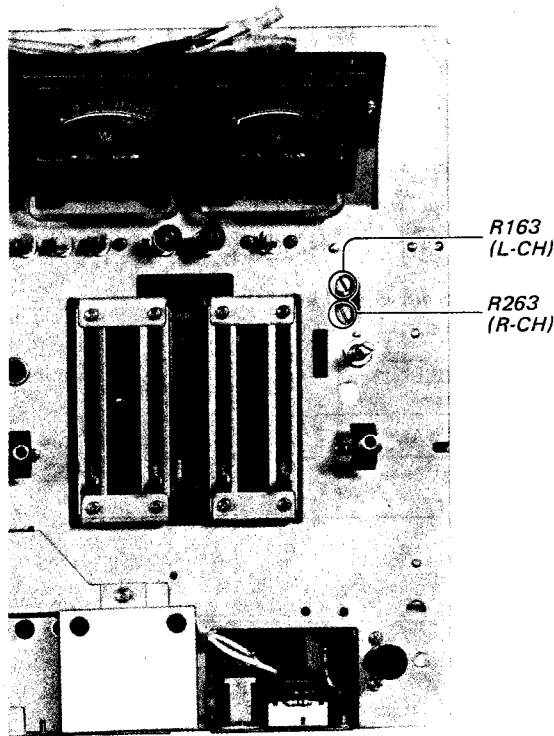

10. LIMITER Operation Check

Procedure:

1. Mode: Standard record (See page 13.)

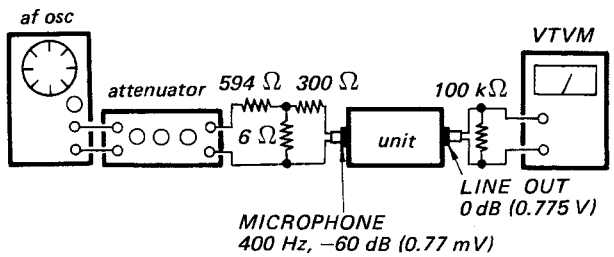

2. LIMITER switch: ON

MICROPHONE	LINE OUT
-60 dB (0.77 mV)	$-1.5 \sim +0.5$ dB (0.66 ~ 0.82 V)
-30 dB (25 mV)	$+3 \sim +6$ dB (1.1 ~ 1.6 V)

11. MIC Control Balance Check

Procedure:

1. Mode: Standard record (See page 13.)

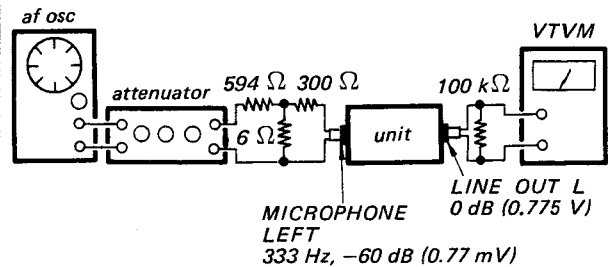

2. Connect input signal to MICROPHONE RIGHT and VTVM to LINE OUT R.
3. Set the MIC (R) control to the same position as that of the MIC (L) control.
Output level difference from L-CH should be less than 3 dB.

12. LINE Control Balance Check

Procedure:

1. Mode: Standard record (See page 13.)

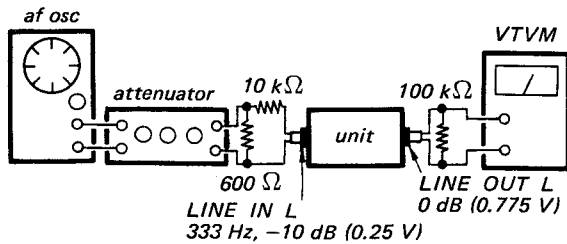

2. Connect input signal to LINE IN R and VTVM to LINE OUT R.
3. Set the LINE R control to the same position as that of the LINE L control.
Output level difference from L-CH should be less than 3 dB.

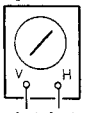
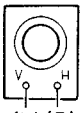
Adjust	Oscilloscope patterns
azimuth adjustment screw to obtain the in-phase pattern at maximum VTVM readings.	<p>[Allowance]</p> <p><i>in-phase</i>  <i>90° out-of-phase</i> </p> <p>(L) (R) (L) (R)</p> <p>Should be obtained at less than 1 dB level difference between channels.</p>

Note: Do not adjust playback head adjustment screw.

Adjustment Location:

record head azimuth adjustment screw

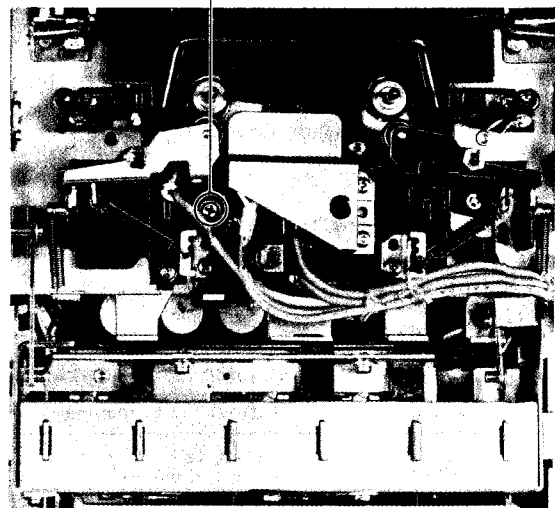

13. Record Head Azimuth Adjustment

Procedure:

1. Mode: Standard record (See page 13.)

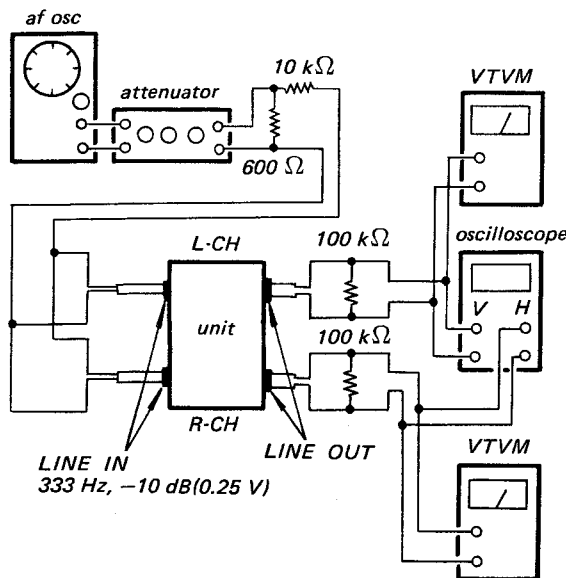

REC CAL controls: Mechanical mid

2. Mode: Record
Apply 10 kHz, -40 dB (7.7 mV) signal to the LINE IN L and R, and carefully adjust record head azimuth adjustment screw to obtain highest VTVM readings.

14. Record Level Adjustment

Procedure:

1. Mode: Standard record and simultaneous playback
MONITOR switch: TAPE

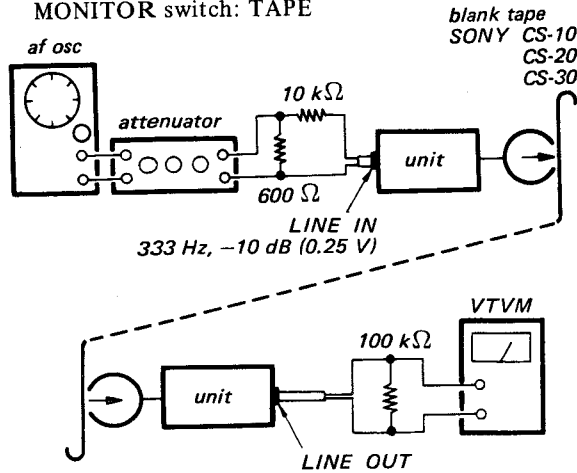

Adjust REC CAL controls R364 (L-CH) and R464 (R-CH) to obtain 0 dB (0.775 V) VTVM reading.

Note: Do not adjust these controls after this adjustment.

2. Change the blank tape to CS-20 and CS-30, and perform the same record and playback procedure. Measure LINE OUT level.

Specification:

SONY tape	LINE OUT level
CS-10	0 dB (0.775 V, reference)
CS-20	-1 ~ 0 dB (0.69 ~ 0.775 V)
CS-30	-1 ~ +1 dB (0.69 ~ 0.85 V)

Adjustment Location:

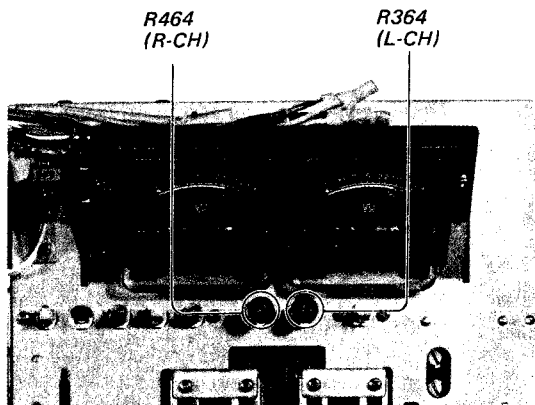

15. Record Bias Adjustment

Procedure:

1. Mode: Record and simultaneous playback
MONITOR switch: TAPE
LINE control: standard record position

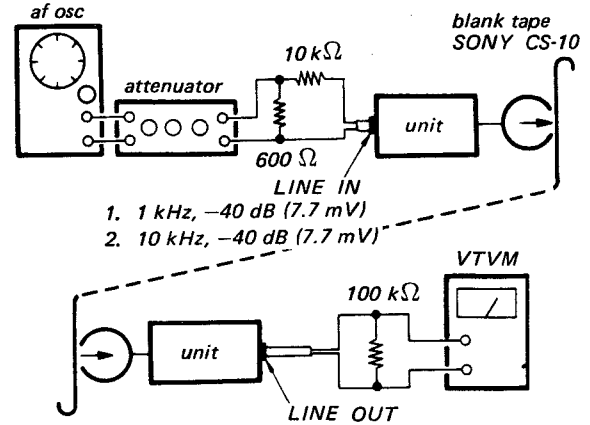

Note LINE OUT level with 1 kHz input signal.

2. With 10 kHz input signal, adjust C356 (L-CH) and C456 (R-CH) to obtain output signal 0.5 dB lower than that obtained in step 1.
When these adjustments are turned clockwise, higher-frequency-component output level drops.
3. Set the BIAS switch to MEDIUM and assure that the 10 kHz output level drops.

Specification:

10 kHz LINE OUT level drop from 1 kHz
LINE OUT level: 1 dB maximum
Level difference between channels:
less than 0.5 dB

Adjustment Location:

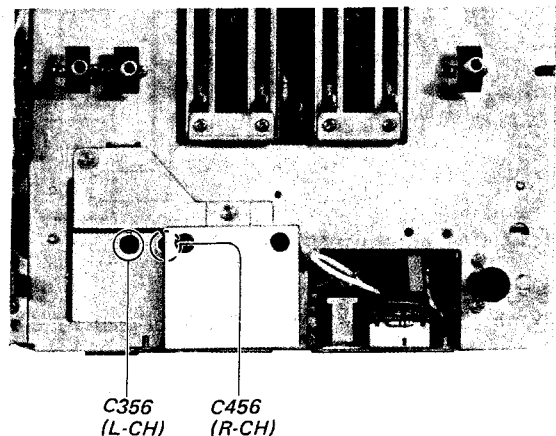

16. Playback Trap Adjustment

Procedure:

Mode: Playback

MONITOR switch: TAPE

CS-20 (blank tape)

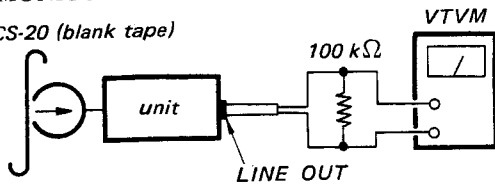

Adjust L101 (L-CH) and L201 (R-CH) to obtain minimum LINE OUT voltage.

Note: VTVM should be able to handle frequency higher than 150 kHz.

Specification: -45 dB (4.4 mV) or lower

Adjustment Location:

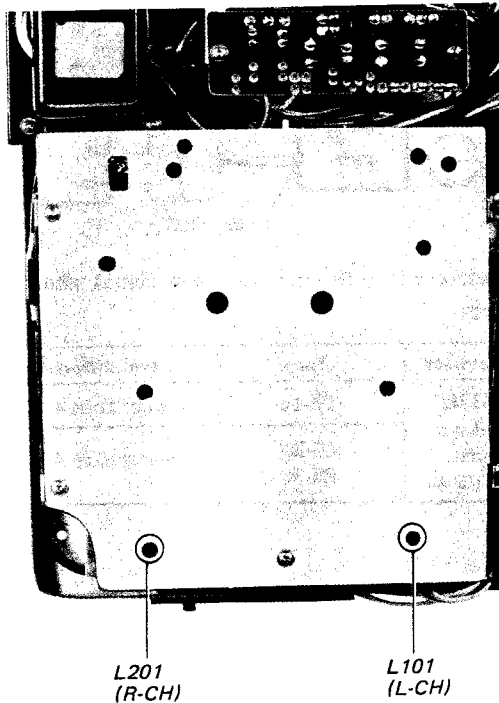

17. Bias Leakage Measurement

Procedure:

1. Mode: Record

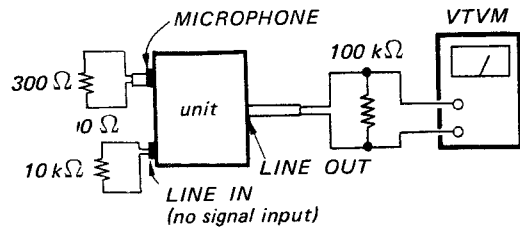

Note: Be sure not to pick up hum noise at the dummy resistors and input jacks. Do not use shielded wire for VTVM connection.

Adjust LINE control from MIN to MAX and measure the maximum level.

Specification: -45 dB (4.4 mV) or lower

18. Overall Frequency Response Measurement

Procedure:

- Mode: Record and simultaneous playback
 MONITOR switch: TAPE
 LINE control: standard record position

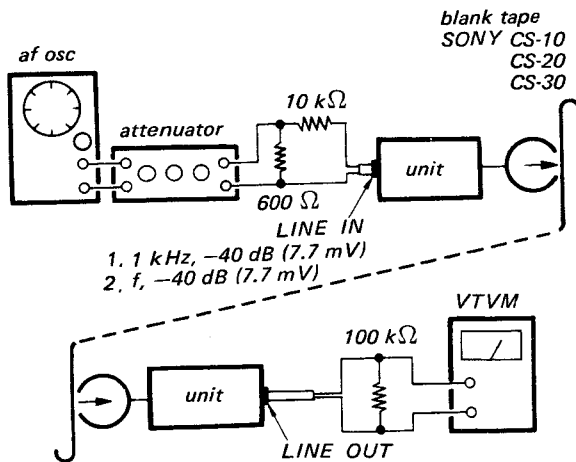

- Measure LINE OUT level difference from that of 1 kHz output level.

Tape	f	Level difference				
		30 Hz *	7 kHz	10 kHz	12.5 kHz	15 kHz
CS-10		+1/-3 dB *	± 1 dB	+0/-1 dB	+1/-3 dB	
CS-20		+1/-3 dB *	± 1 dB			± 3 dB
CS-30		+1/-3 dB *	± 1 dB			± 3 dB

* With 40 Hz: +1/-2 dB

- DOLBY NR switch: ON

In the same manner, measure LINE OUT level difference.

Tape	f	Level difference	
		7 kHz	10 kHz
CS-10		± 3 dB	± 3 dB
CS-20		± 3 dB	± 3 dB
CS-30		± 3 dB	± 4 dB

- When the above specified values are not obtained, adjust record bias slightly or adjust playback equalizer level by ± 1 dB at CrO₂ switch position, and repeat the measurement.

Note: When playback equalizer level at CrO₂ is adjusted in this step, also readjust playback equalizer level at NORMAL position.

19. Overall Signal-to-Noise Measurement

Procedure:

- Mode: Standard record

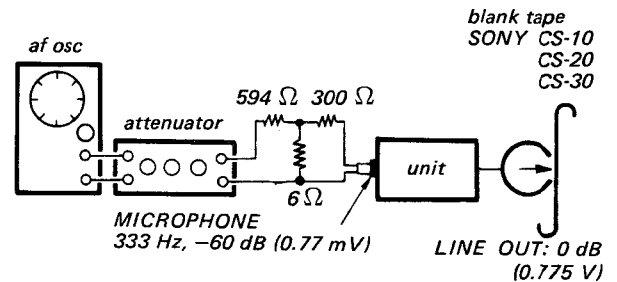

- Mode: Record

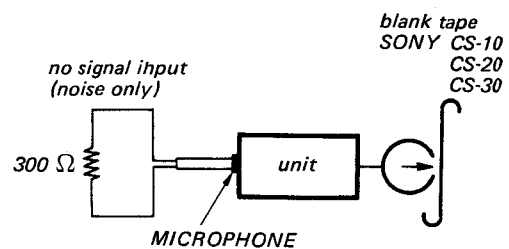

- Mode: Playback

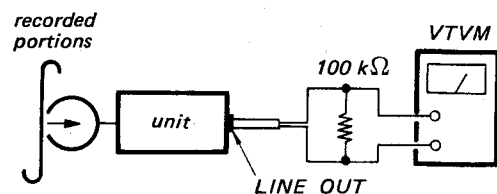

- Measure the difference between signal and noise levels.

Playback	Tape	Level difference
333 Hz and no signal portions	CS-10	greater than 40 dB
	CS-20, CS-30	greater than 47 dB

20. 19 kHz Filter Measurement

Procedure:

1. Mode: Standard record

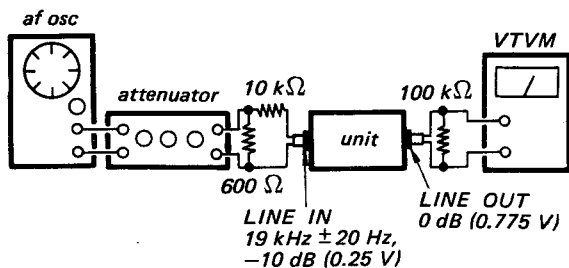

2. Mode: Standard record
DOLBY NR switch: ON
FILTER switch: ON
- Measure LINE OUT level.

Specification: lower than -20 dB (77 mV)

22. Erase Ratio Measurement

Procedure:

1. Mode: Record
MIC control: standard record position

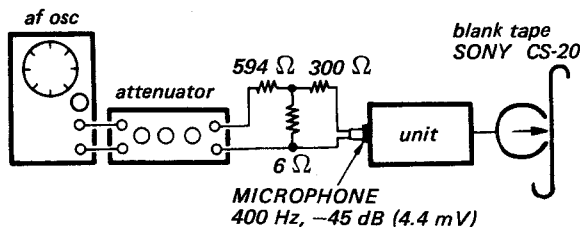

2. Rewind half of recorded portion.
3. Set the MIC control to MIN position.
4. Mode: Record

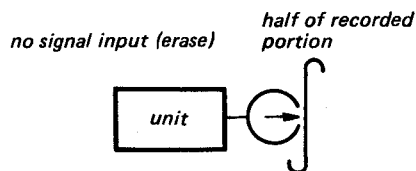

5. Mode: Playback

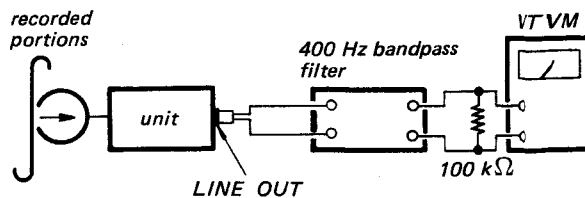

Measure level difference.

Playback	VTVM reading
400 Hz	level difference: more than 60dB
erased portion	

Note: When a 1 kHz bandpass filter is used, use 1 kHz signal. In case of 1 kHz system the level difference is more than 65 dB.

21. DOLBY Signal-to-Noise Ratio Measurement

Procedure:

1. Mode: Record
LINE control: MIN

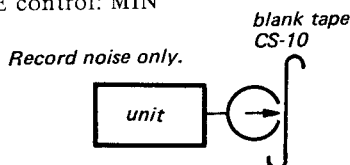

2. Mode: Playback
DOLBY NR switch: ON and OFF
LINE control: MIN
MONITOR switch: TAPE

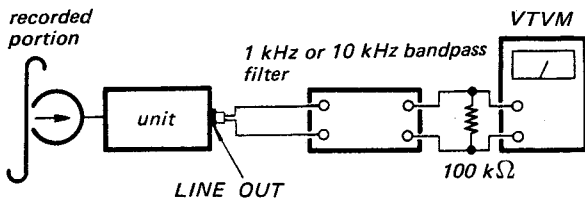

Measure level difference by switching the DOLBY NR switch ON and OFF.

bandpass filter	DOLBY signal-to-noise ratio improvement
1 kHz	more than 4 dB
10 kHz	more than 8 dB

23. Cross Talk Measurement (between channels)

Procedure:

1. Mode: Standard record

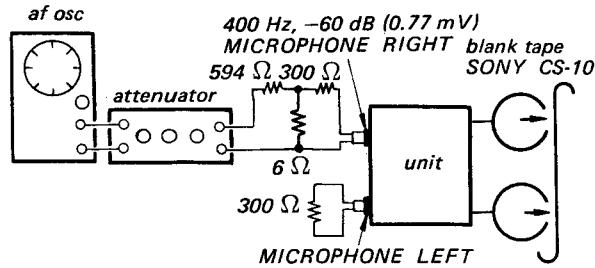

Set MIC (L) control to the same as MIC (R) control position for standard recording.

2. Mode: Playback

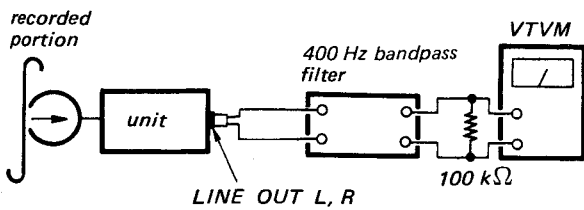

Playback	VTVM reading
R-CH (400 Hz)	level difference: more than 30 dB
L-CH (no signal)	

24. Cross Talk Measurement (between tracks)

Procedure:

1. Mode: Standard record

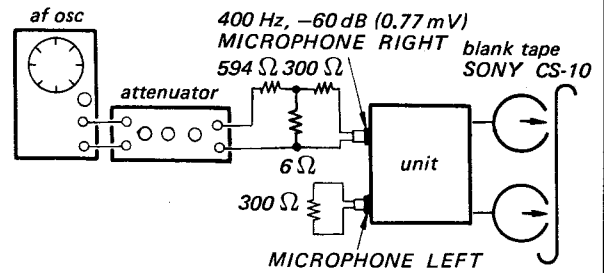

Set MIC (L) control to the same as MIC (R) control position for standard recording.

2. Mode: Playback

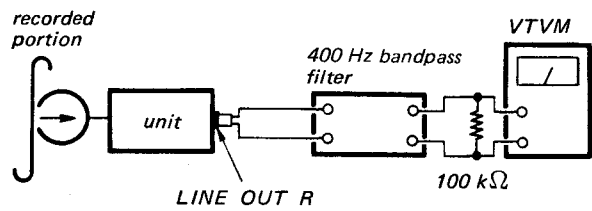

3. Turn the cassette over.

4. Mode: Playback

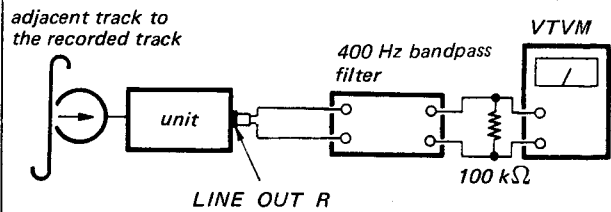

Playback	VTVM reading
400 Hz	level difference: more than 60 dB
adjacent track to recorded track	

25. Tape Speed Measurement

Procedure:

Mode: Playback
LINE OUT control: Mechanical mid

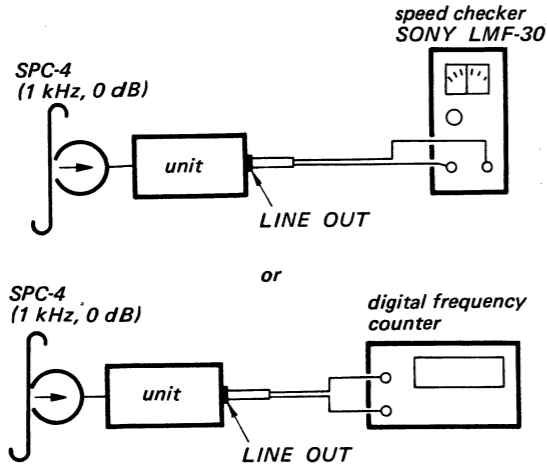

Specification:

speed checker	digital frequency counter
-1 ~ +1%	990 ~ 1010 Hz

Frequency difference between beginning and end of tape should be within 1% (10 Hz).

4-1. LEVEL DIAGRAMMS

Record

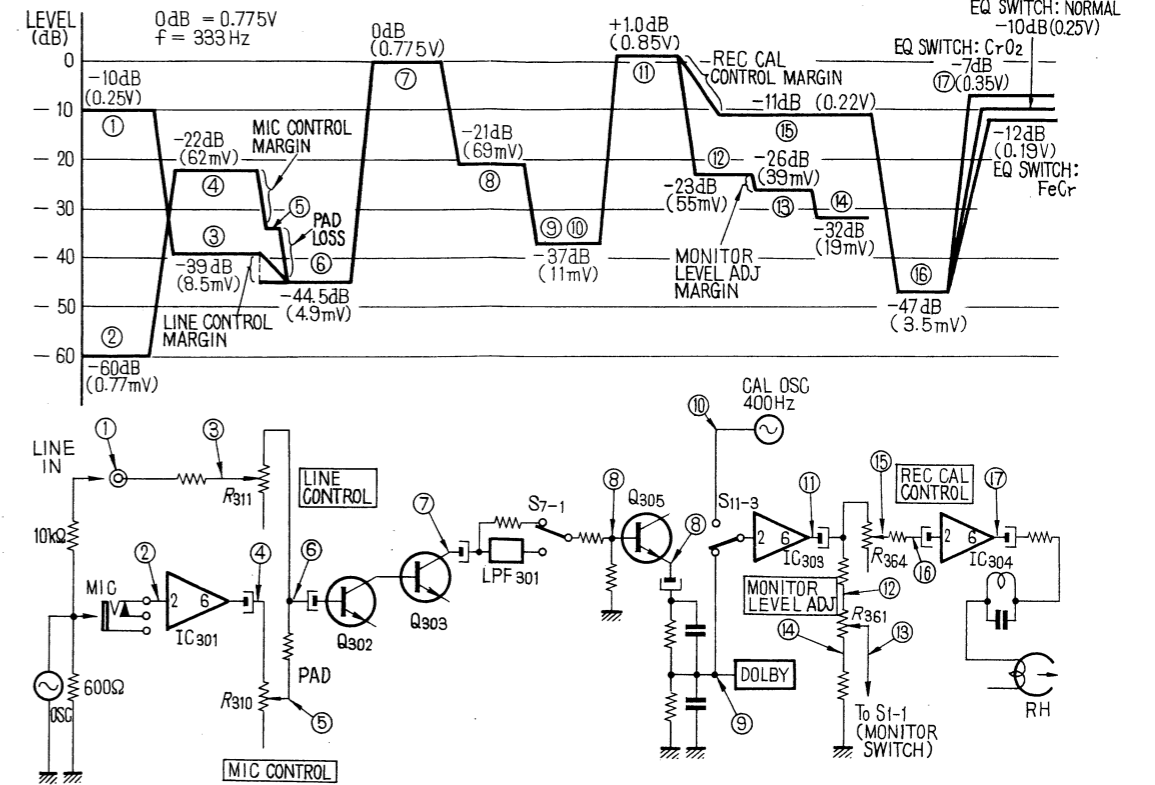

Playback

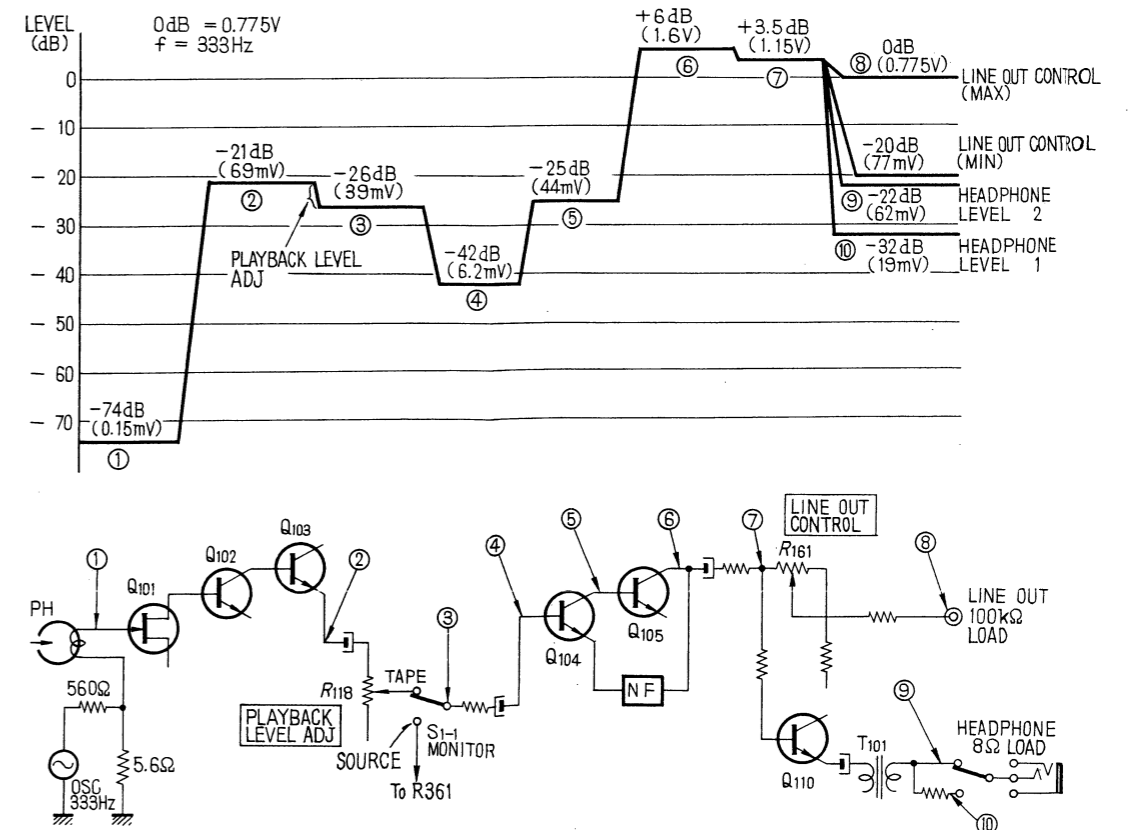

TC-177SD TC-177SD

4-2. SCHEMATIC DIAGRAM (1)

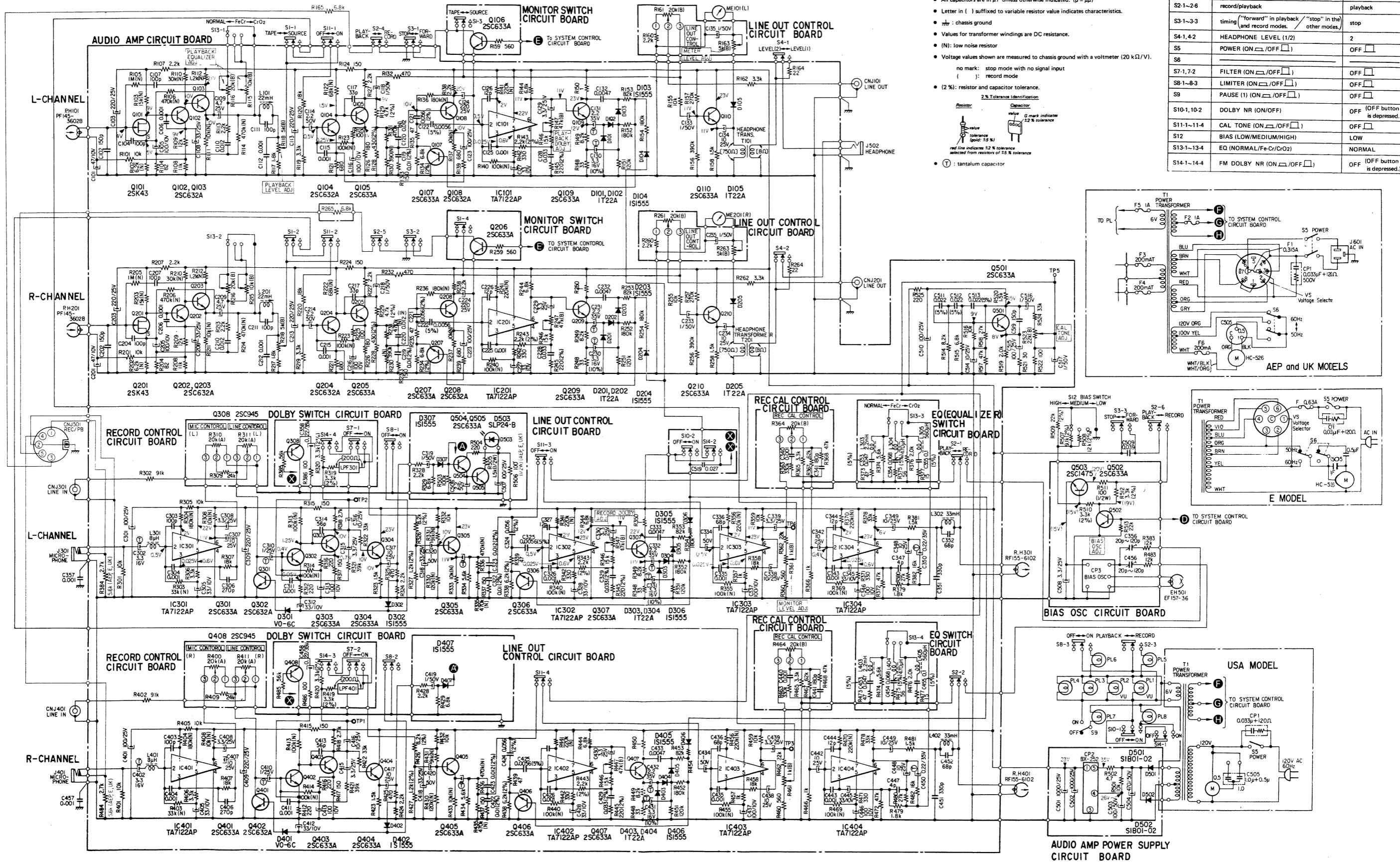

Note:

- All resistors are in Ω , $k\Omega$ and carbon type unless otherwise indicated. ($k = 1000$)
- All capacitors are in μF unless otherwise indicated. ($\mu = \mu\mu$)
- Letter in () suffixed to variable resistor value indicates characteristics.
- --- : chassis ground
- Values for transformer windings are DC resistance.
- (N): low noise resistor
- Voltage values shown are measured to chassis ground with a voltmeter (20 $k\Omega/V$).
- no mark: stop mode with no signal input
- (): record mode
- (2%): resistor and capacitor tolerance

2% Tolerance Identification

Resistor: Capacitor:

0 mark indicates 2% tolerance
Tolerance (50p 15%)
red line indicates 2% tolerance selected from resistors of 15% tolerance

⊕: tantalum capacitor

Ref. No.	Switch	Mode
S1-1-1-4	MONITOR (SOURCE/TAPE)	TAPE
S2-1-2-6	record/playback	playback
S3-1-3-3	timing ("forward" in playback / "stop" in the other modes)	stop
S4-1,4,2	HEADPHONE LEVEL (1/2)	2
S5	POWER (ON/OFF)	OFF
S6		
S7-1,7,2	FILTER (ON/OFF)	OFF
S8-1-8-3	LIMITER (ON/OFF)	OFF
S9	PAUSE (1) (ON/OFF)	OFF
S10-1,10-2	DOLBY NR (ON/OFF)	OFF (OFF button is depressed.)
S11-1-11-4	CAL TONE (ON/OFF)	OFF
S12	BIAS (LOW/MEDIUM/HIGH)	LOW
S13-1-13-4	EQ (NORMAL/Fe-Cr/CrO2)	NORMAL
S14-1-14.4	FM DOLBY NR (ON/OFF)	OFF (OFF button is depressed.)

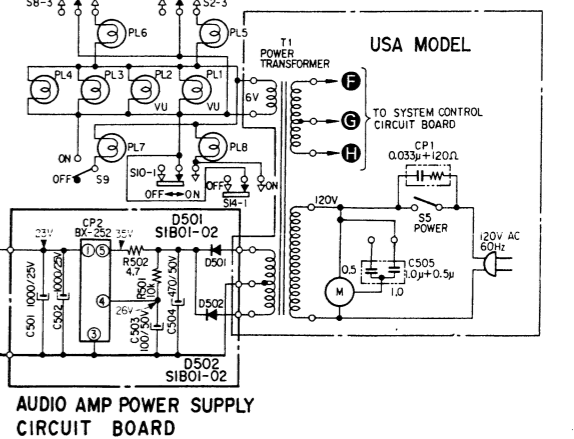
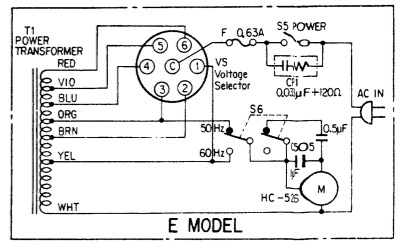
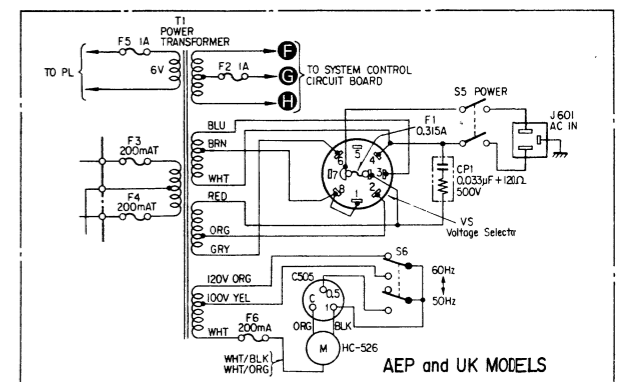

4-3. MOUNTING DIAGRAM (1)
- Conductor Side

Q101 (201): 2SK43

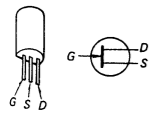

Q102 ~ 104 (202 ~ 204),
Q108 (208), 302 (402) : 2SC632A

Q105 ~ 107 (205 ~ 207),
Q109 (209), 110 (210),
Q301 (401), 303 ~ 307 : 2SC633A
(Q403 ~ 407), 501, 502,
Q504, 505

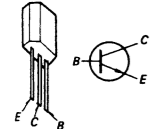

Q308 (408): 2SC945

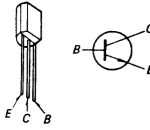

Q503: 2SC1475

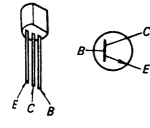

IC101 (201), 301 (401)
IC302 (402), 303 (403): TA7122AP
IC304 (404)

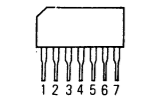

D101 (201), 102 (202),
D105 (205), 303 (403) : 1T22A
D304 (404)

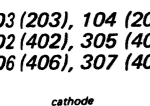

D103 (203), 104 (204),
D302 (402), 305 (405), 1S1555
D306 (406), 307 (407)

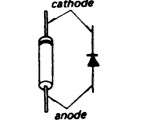

D301 (401): V06C

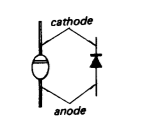

D501, 502: S1B01-02

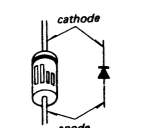

D503: SLP24-B

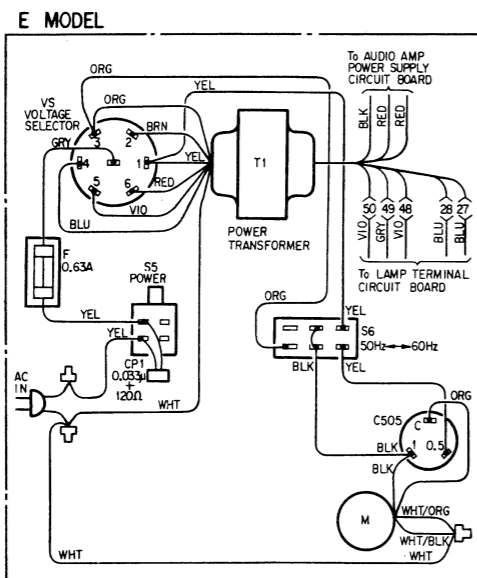
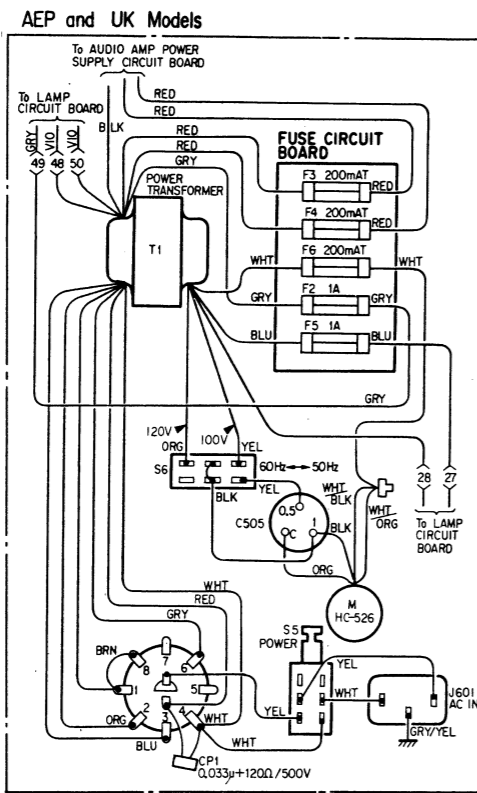
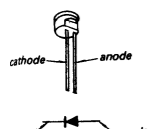

Note: Colour indication for the lead wires.
example: BLU (RED)

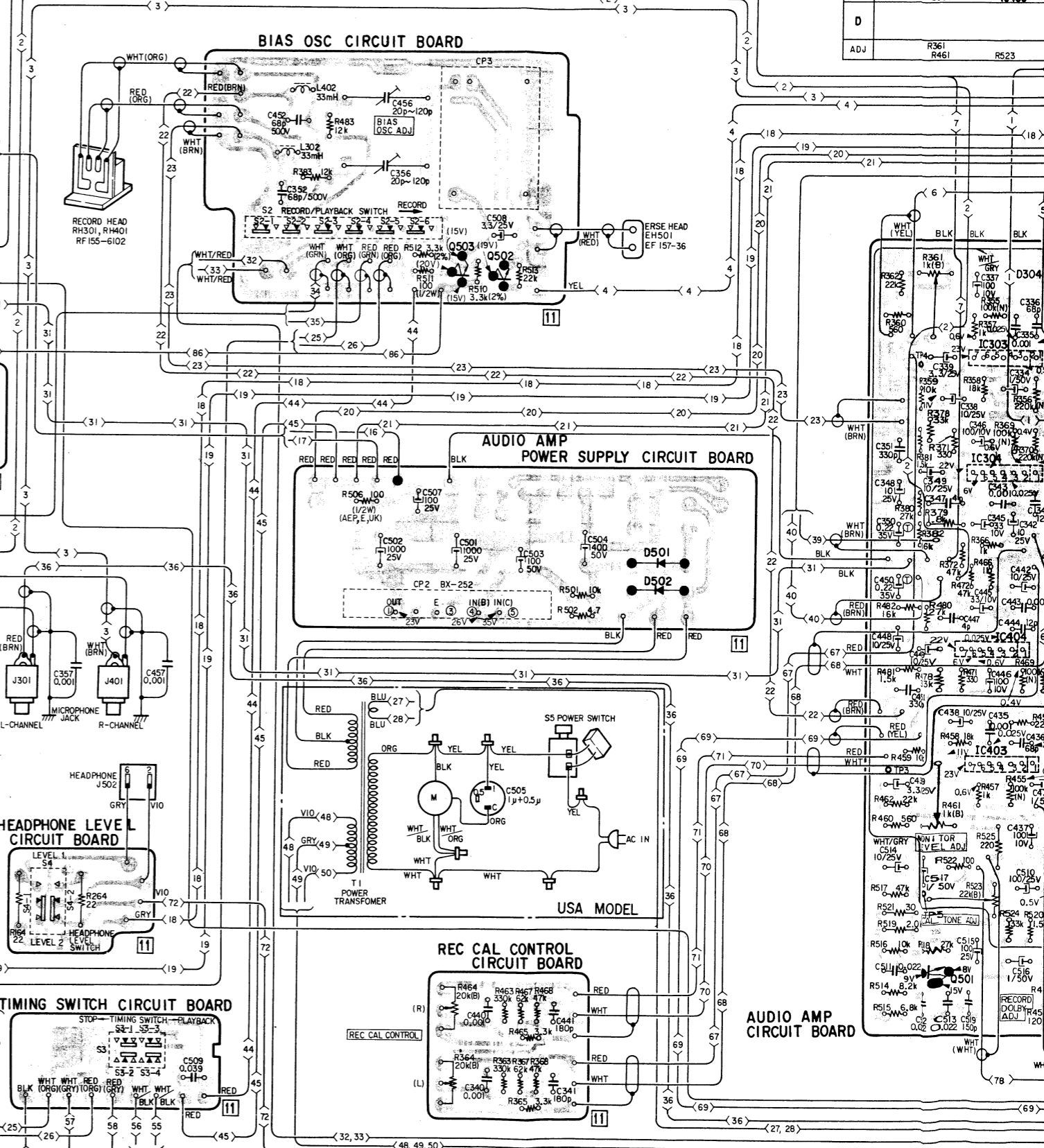
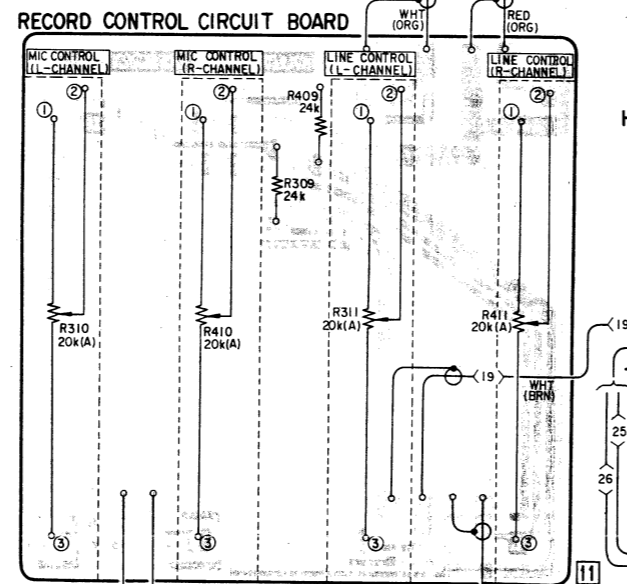
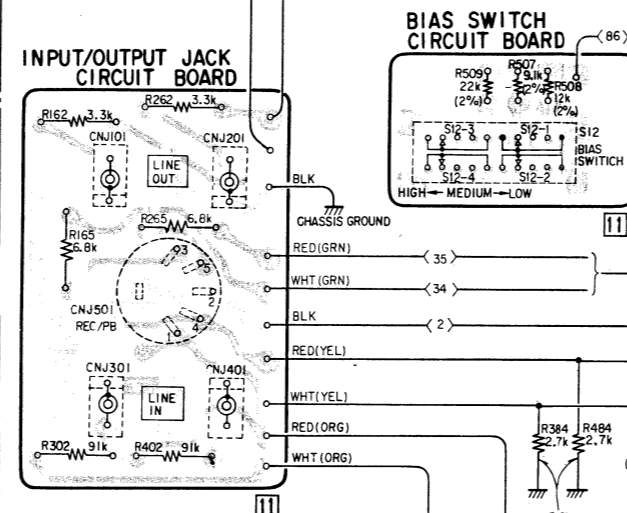
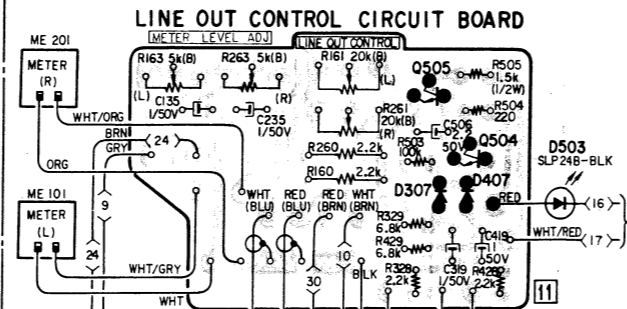

Q	IC	Q501	IC303	IC304	IC404	IC403
ADJ		R361	R461	R523		

Q	IC303	Q306	Q305	IC302	Q307	Q109	Q303	Q107	IC101	Q110	Q108	Q103	Q101	Q105	Q104
IC	0501	0304	0306	0304	0307	0209	0403	0402	IC201	IC401	Q208	Q202	Q201	Q205	Q204
D		D304	D303	D305	D103	D102	D101	D104	D105						
ADJ	R361	R461	R523	R447	R347			R147	R247						

JIT BOARD

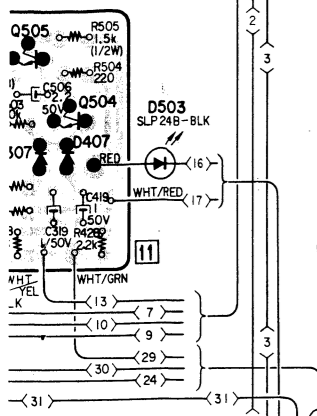

BIAS OSC CIRCUIT BOARD

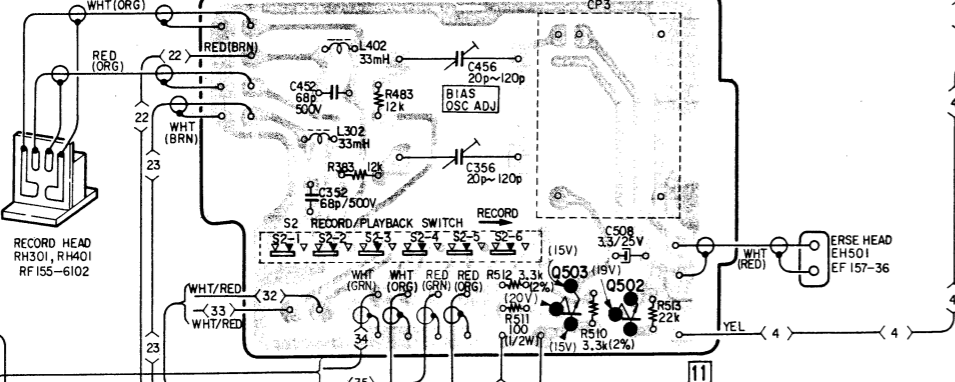

BIAS SWITCH CIRCUIT BOARD

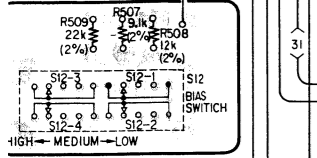

AUDIO AMP POWER SUPPLY CIRCUIT BOARD

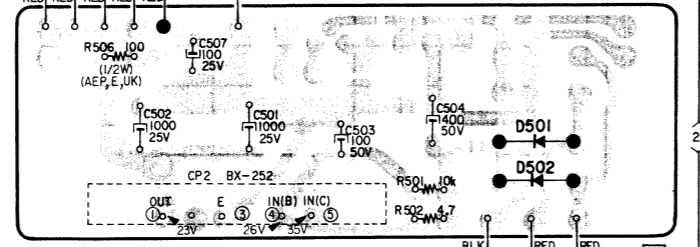

HEADPHONE LEVEL CIRCUIT BOARD

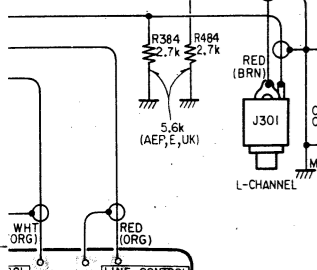

REC CAL CONTROL CIRCUIT BOARD

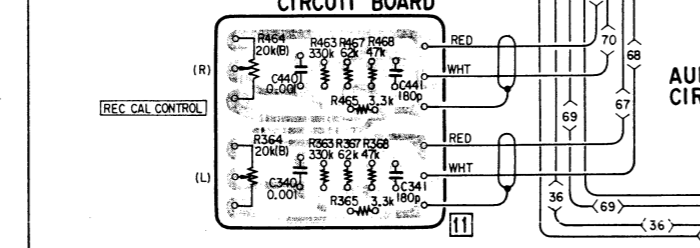

TIMING SWITCH CIRCUIT BOARD

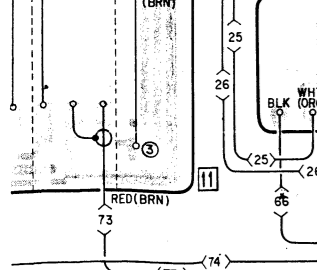

AUDIO AMP CIRCUIT BOARD

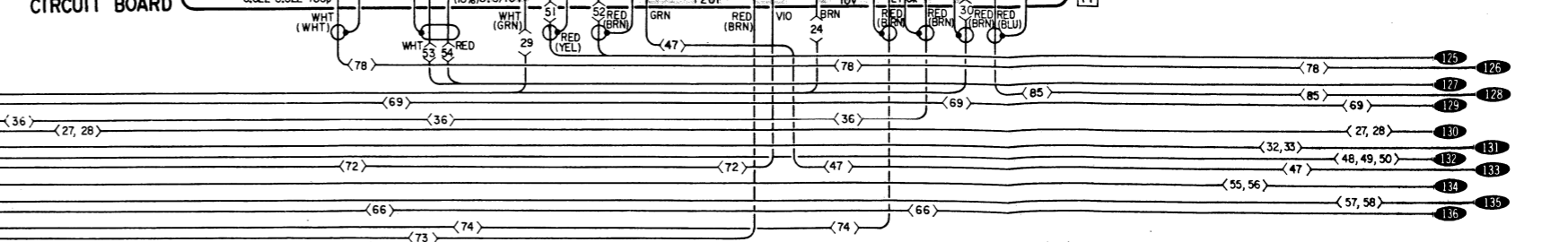

4-4. MOUNTING DIAGRAM (2)
- Conductor Side -

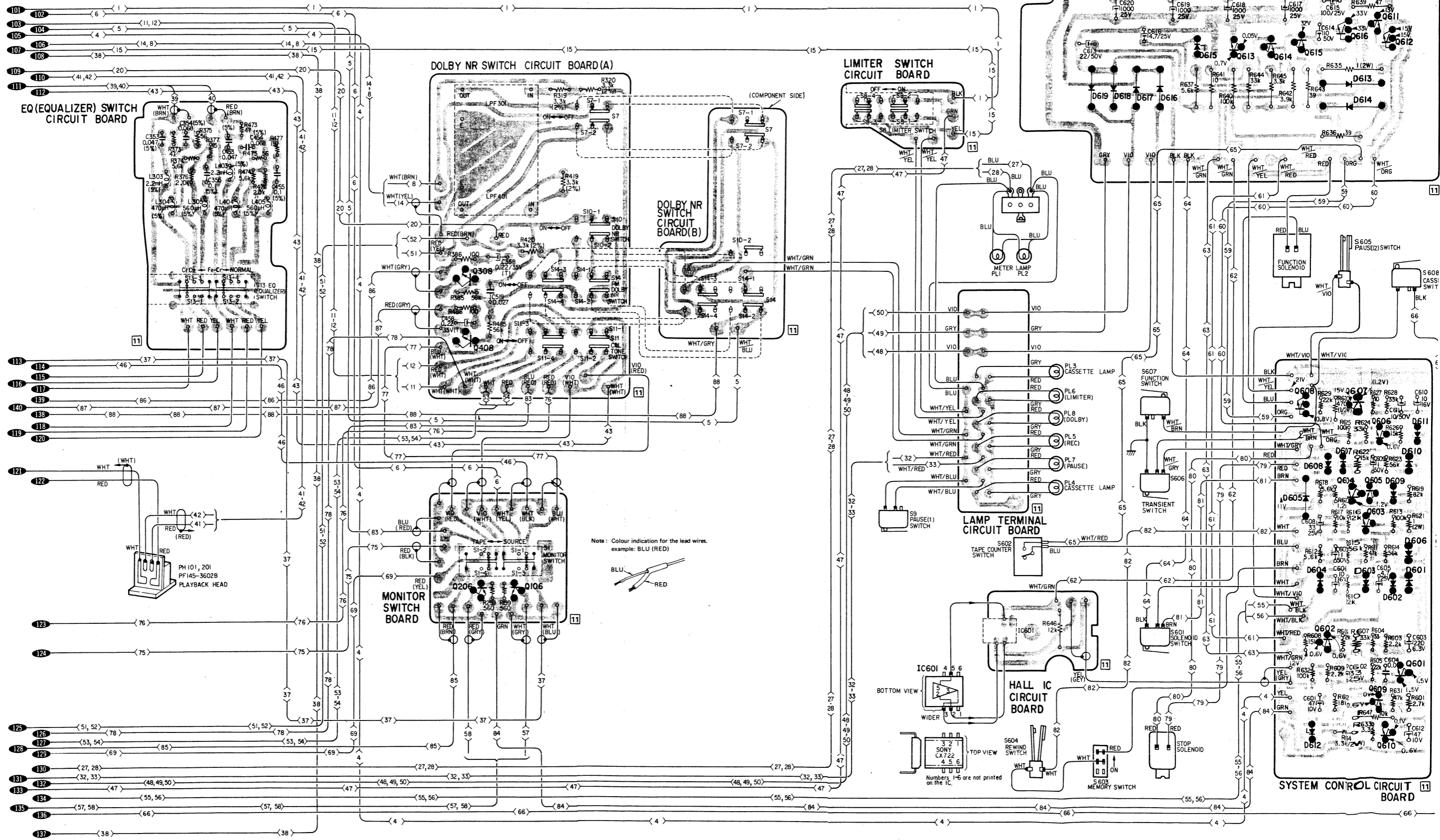

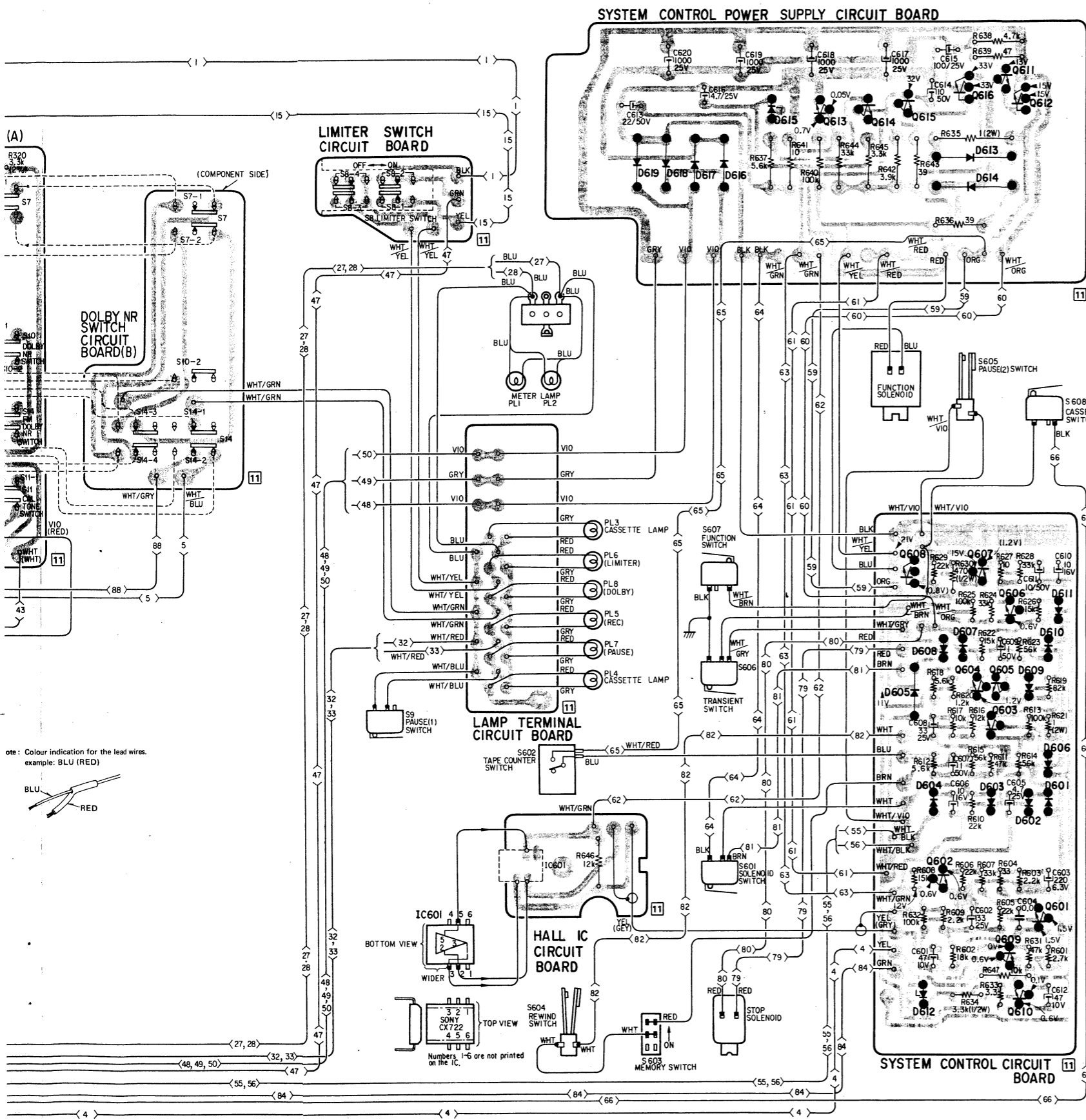

Note: Colour indication for the lead wires.
example: BLU (RED)

Q106 (206): 2SC633A
Q601 ~ 604, 606, 607, 2SC634A
Q609 ~ 611, 613 ~ 615: 2SC634A

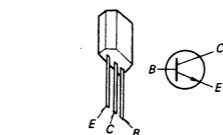

D601 ~ 606, 1T40
D608 ~ 611: 1T40

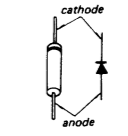

Q605: 2SC1475

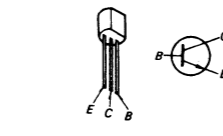

D607, 613, 614: SIB01-02

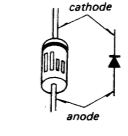

Q608, 612, 616: 2SC1061

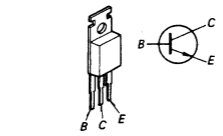

D612: MZ-08
D615: MZ-12

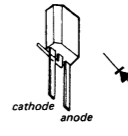

IC601: CX-722

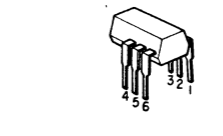

D616 ~ 619: U05E

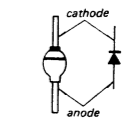

CP2: BX-252

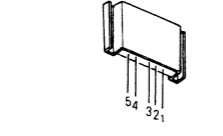

4.5. SCHEMATIC DIAGRAM (2)

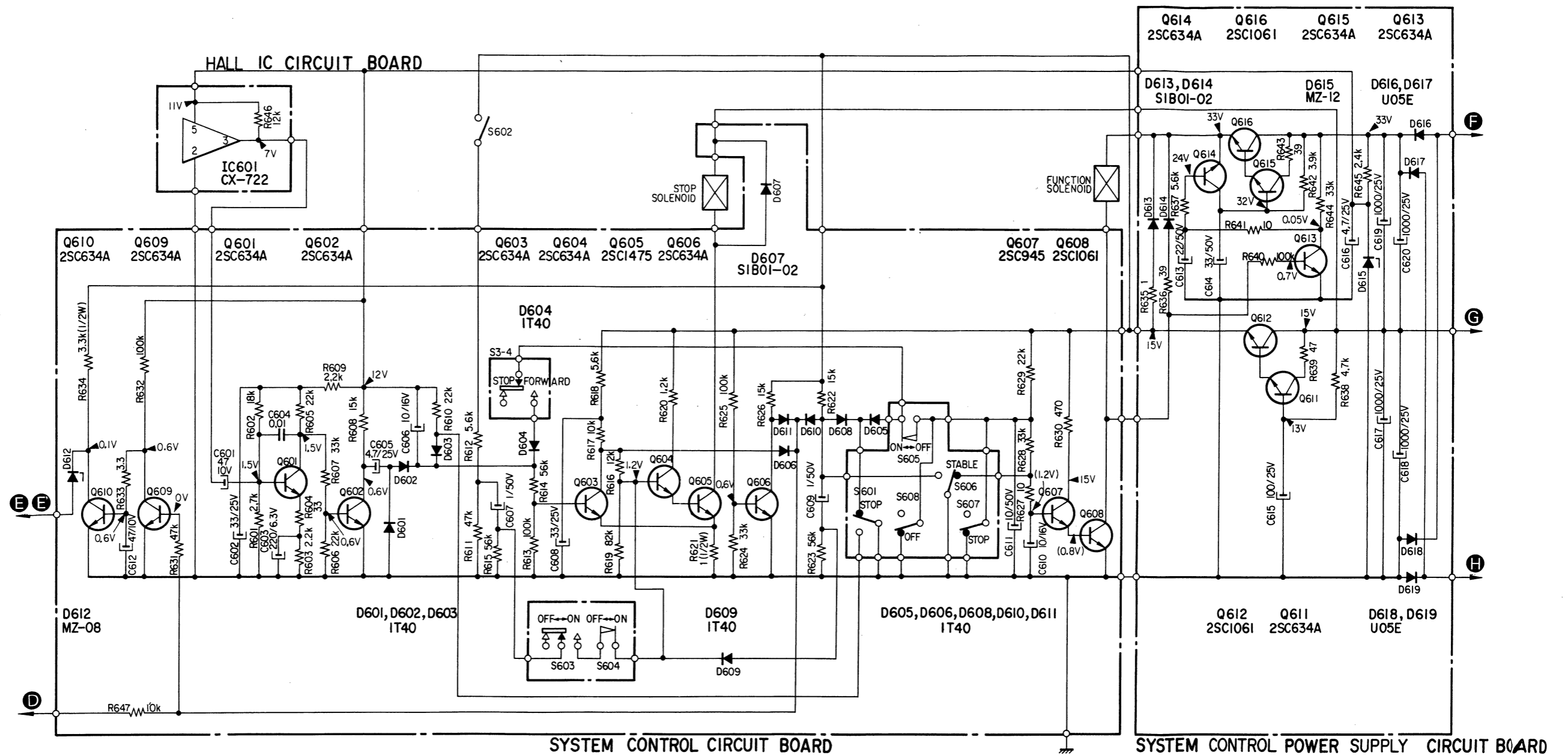

Note:

- All resistors are in Ω , $\frac{1}{4}W$ and carbon type unless otherwise indicated. (k = 1000)
- All capacitors are in μF unless otherwise indicated. ($\mu = \mu\mu$)
- Voltage values shown are measured to chassis ground with a voltmeter (20 k Ω/V).
 no mark: stop mode with no signal input
 (): record, playback, fast forward and rewind modes

Ref. No.	Switch	Mode
S3-4	timing ("forward" in playback and record modes/"stop" in the other modes.)	stop
S601	solenoid (jointed with the function solenoid. "stop" in stop mode/ON in the other modes.)	stop
S602	counter (ON at "000" indication/OFF at the other indications)	OFF
S603	MEMORY COUNTER (ON/OFF)	OFF
S604	rewind (this switch turns ON only when the rewind button is depressed.)	OFF
S605	PAUSE (2) (this switch turns ON to prevent the stop solenoid operation when the PAUSE button is depressed in playback or record mode.)	OFF
S606	transient ("stable" in stop mode/momentary ON in the other modes.)	stable
S607	function ("stop" in stop mode/ON in the other modes.)	stop
S608	cassette (ON when the tape cassette is inserted.)	OFF

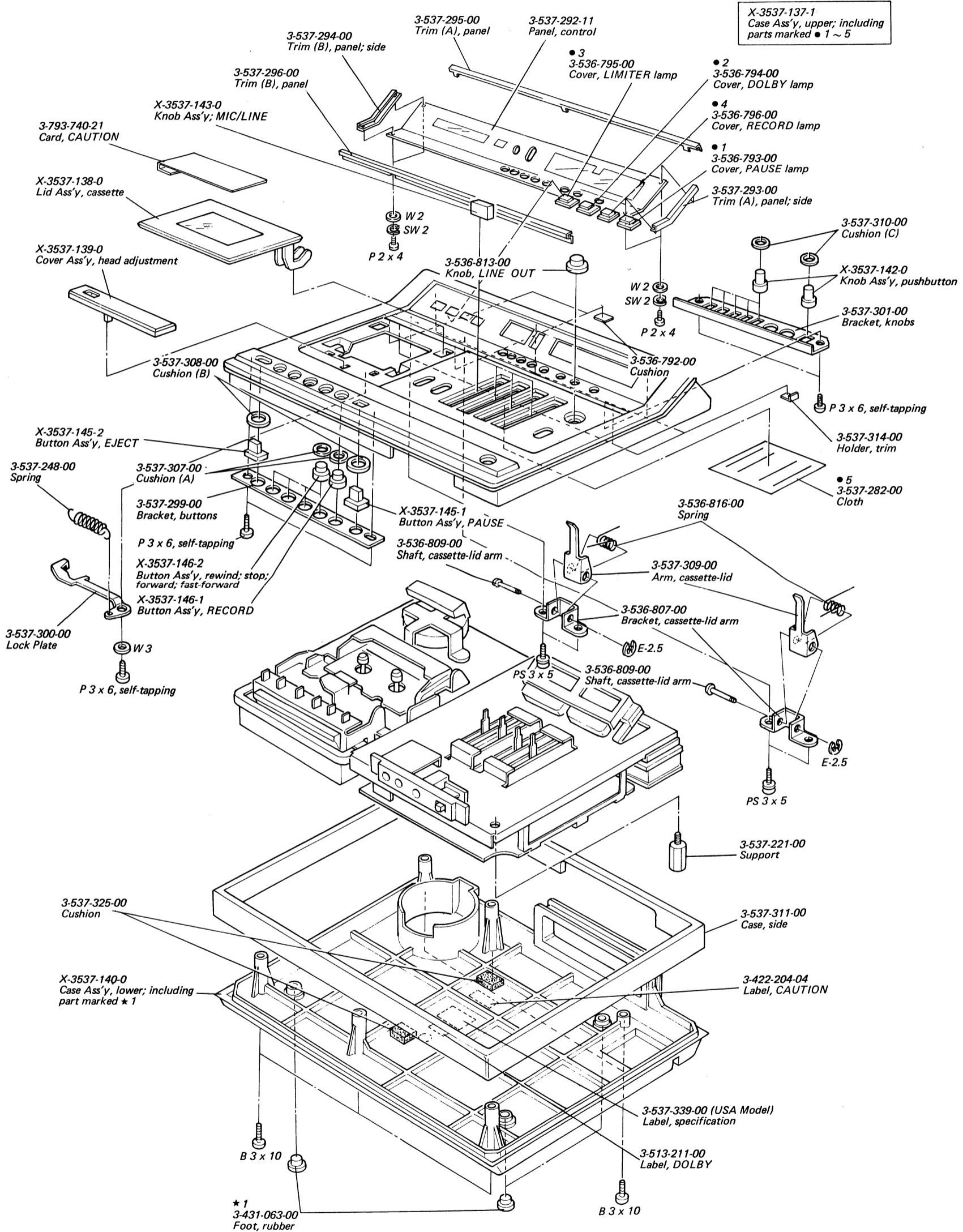

Note:

- Items without part number and description are not available.
- All screws are Phillips (cross recess) type unless otherwise noted.
- (-) = slotted head

X-3537-144-0
Button Ass'y; including all the
parts illustrated on these pages.

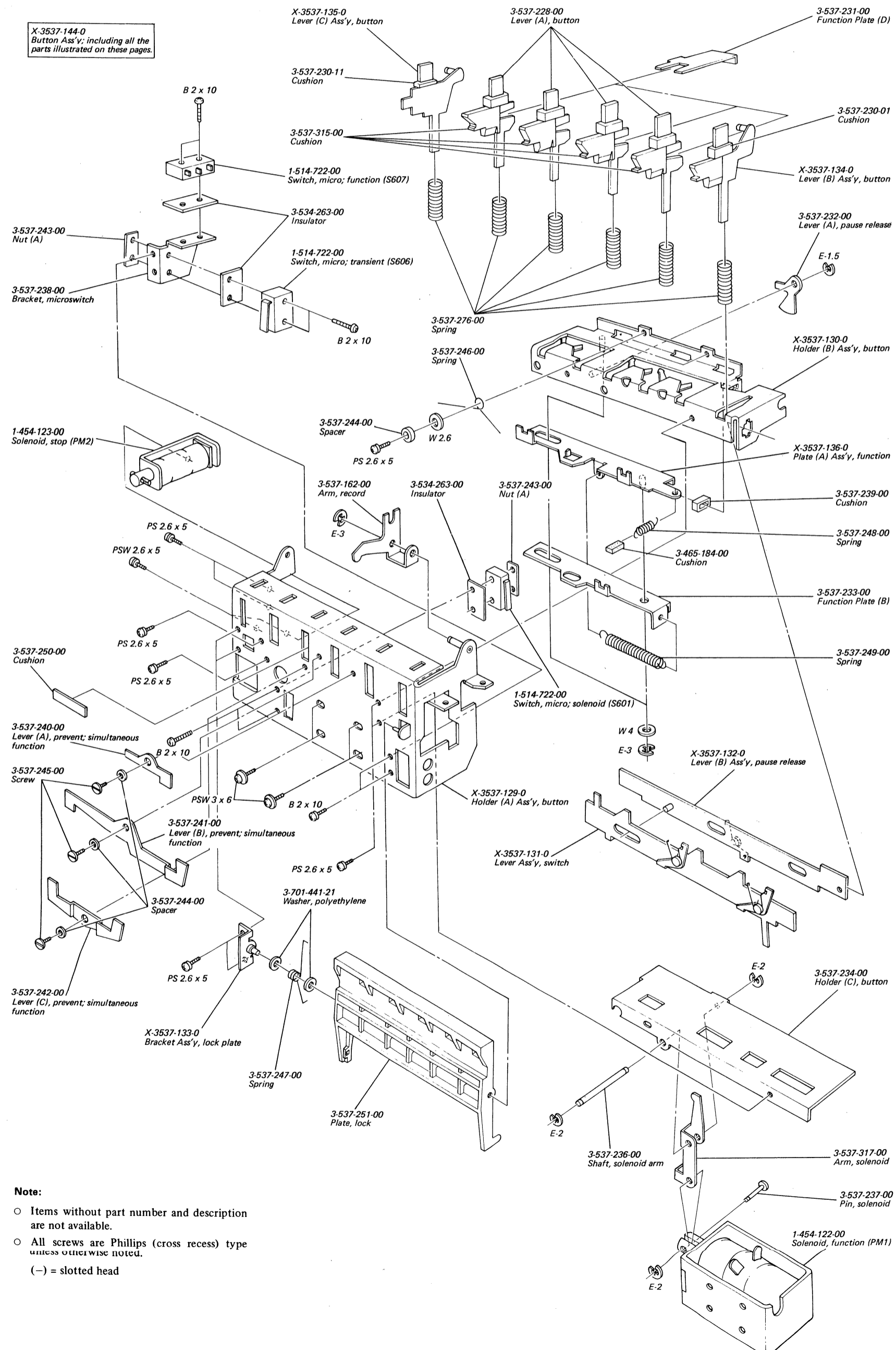

Note:

- Items without part number and description are not available.
- All screws are Phillips (cross recess) type unless otherwise noted.
- (-) = slotted head

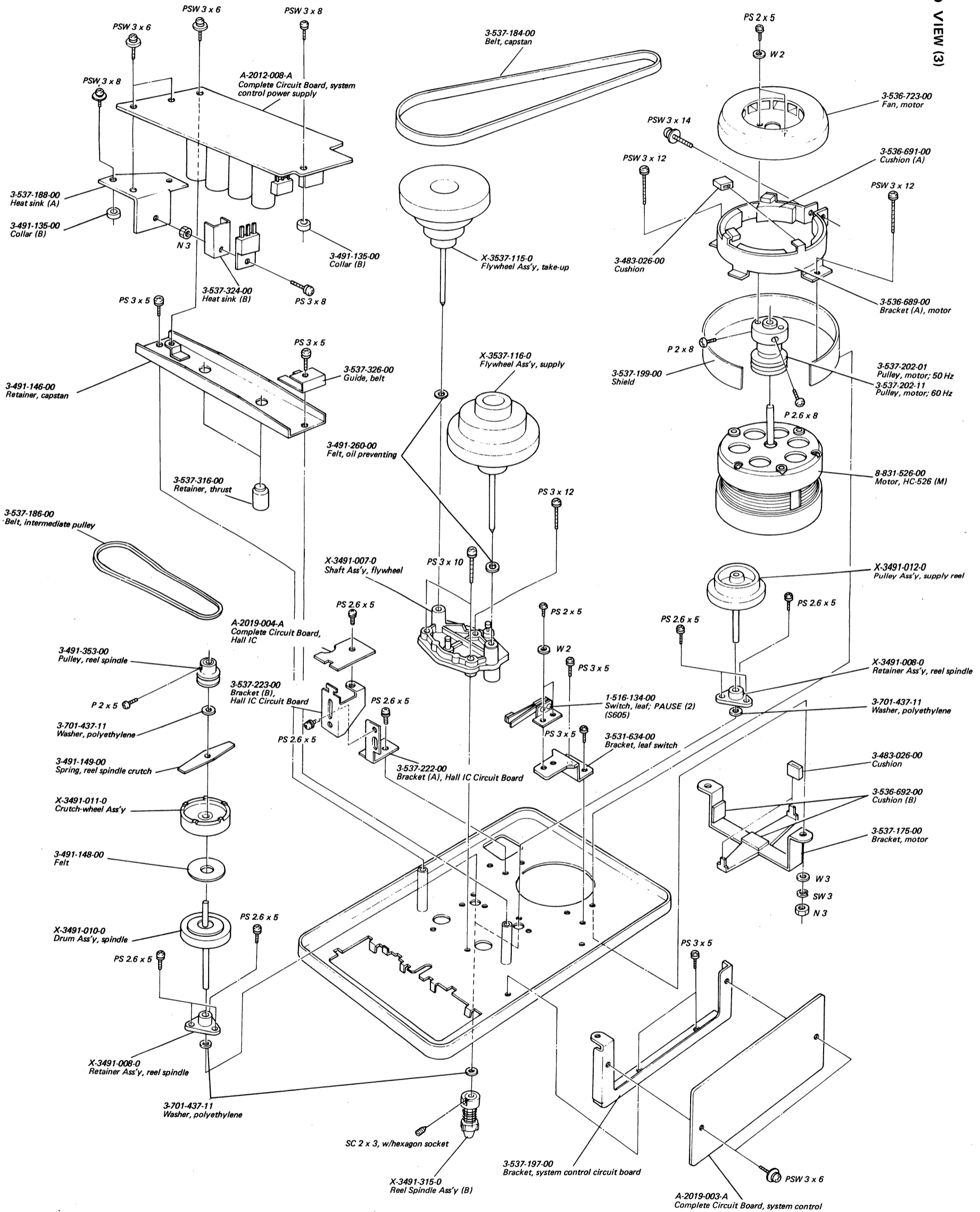

TC-177SD TC-177SD

Note:

- Items without part number and description are not available.
- All screws are Phillips (cross recess) type unless otherwise noted.
- (-) = slotted head

5-4. EXPLODED VIEW (4)

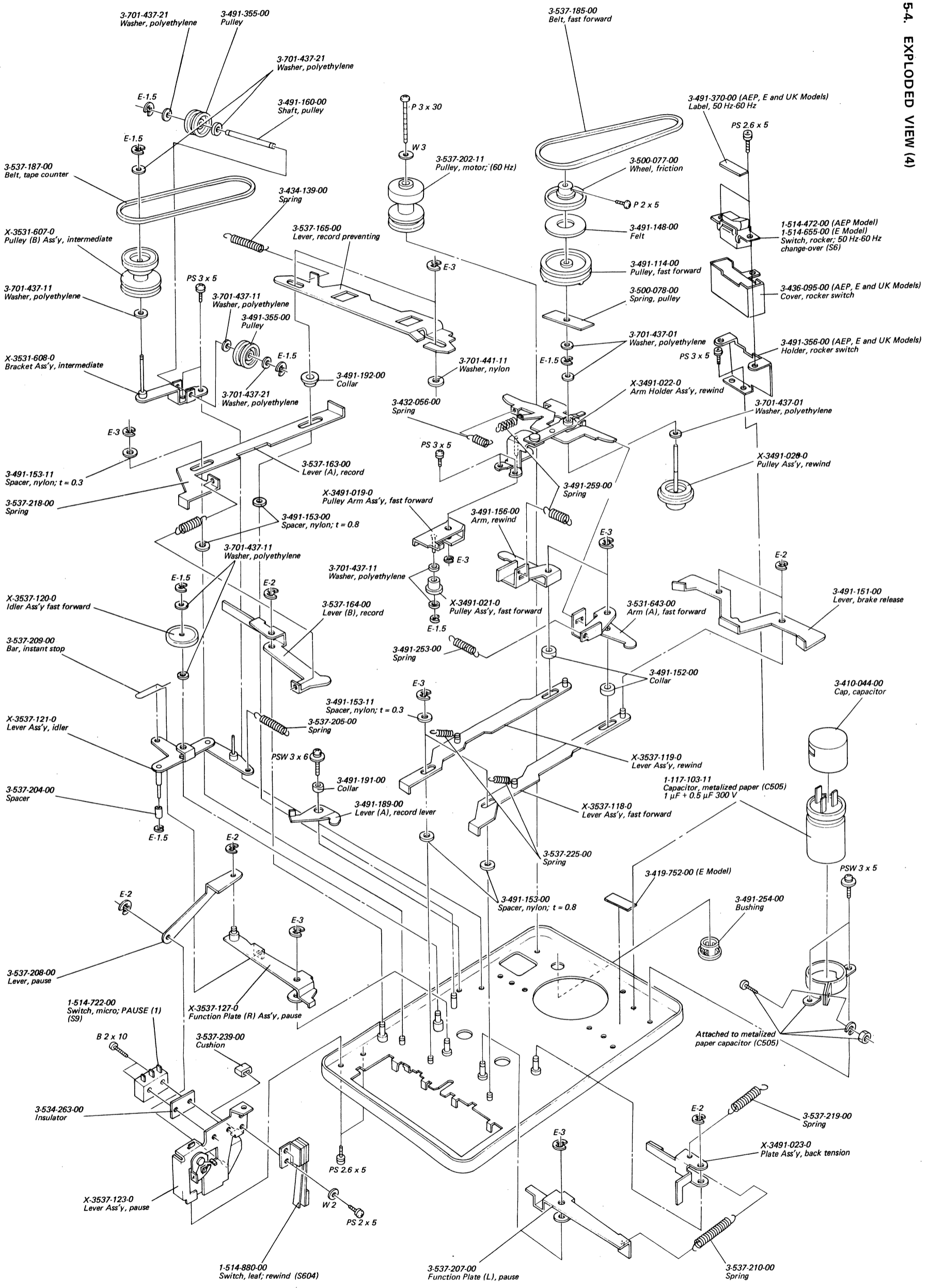

TC-177SD TC-177SD

Note:

- Items without part number and description are not available.
- All screws are Phillips (cross recess) type unless otherwise noted.
- (-) = slotted head

TC-177SD TC-177SD

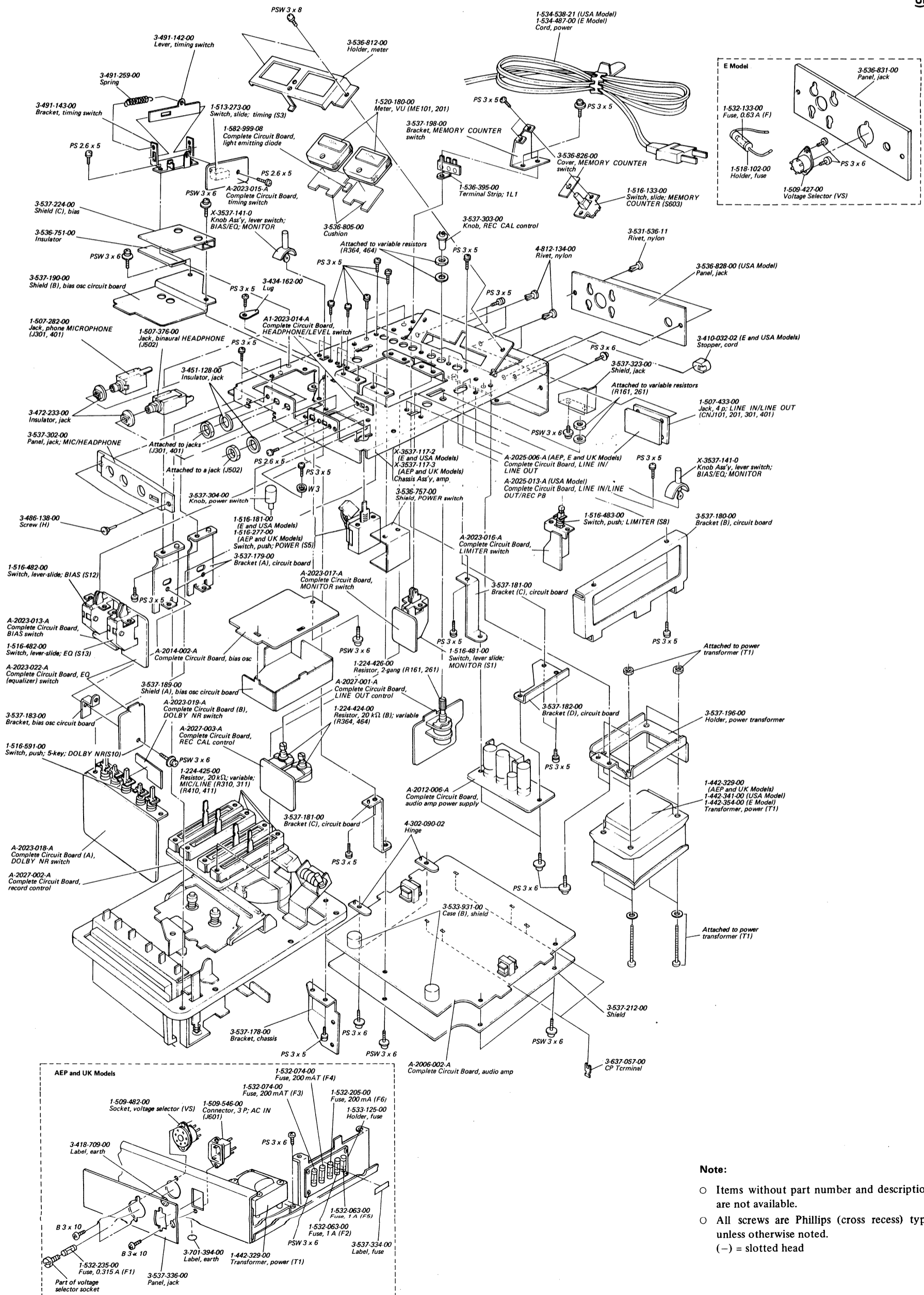

Note:

- Items without part number and description are not available.
- All screws are Phillips (cross recess) type unless otherwise noted.
- (-) = slotted head

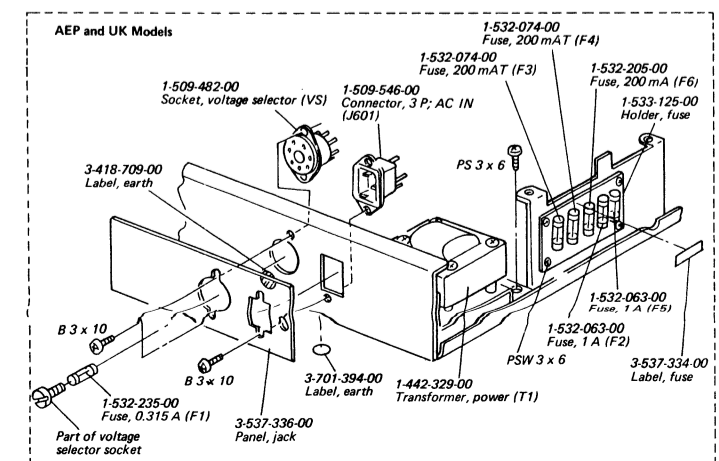

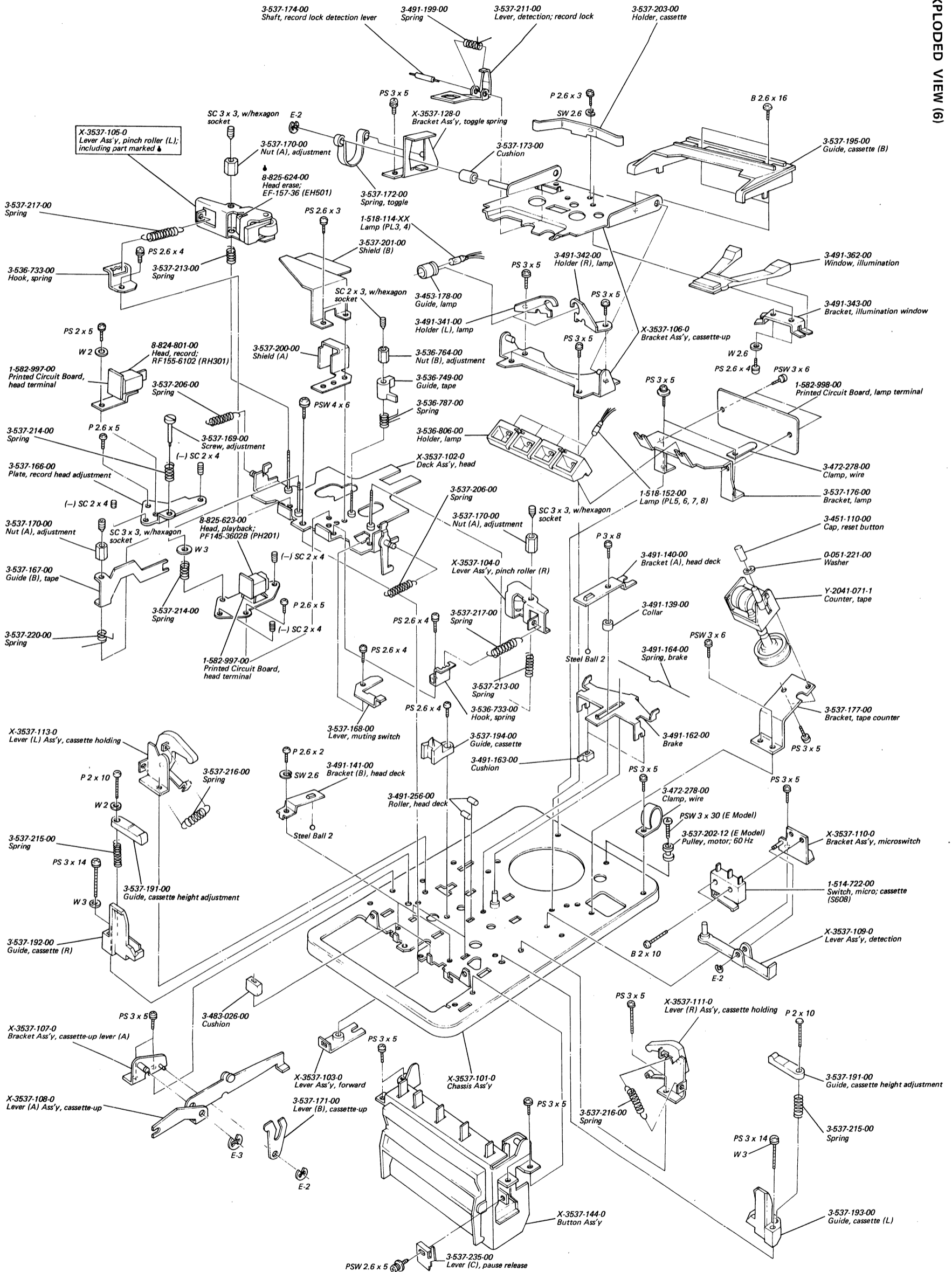

TC-177SD TC-177SD

Note:

- Items without part number and description are not available.
- All screws are Phillips (cross recess) type unless otherwise noted.
- (-) = slotted head

ELECTRICAL PARTS LIST

5-7. PACKING

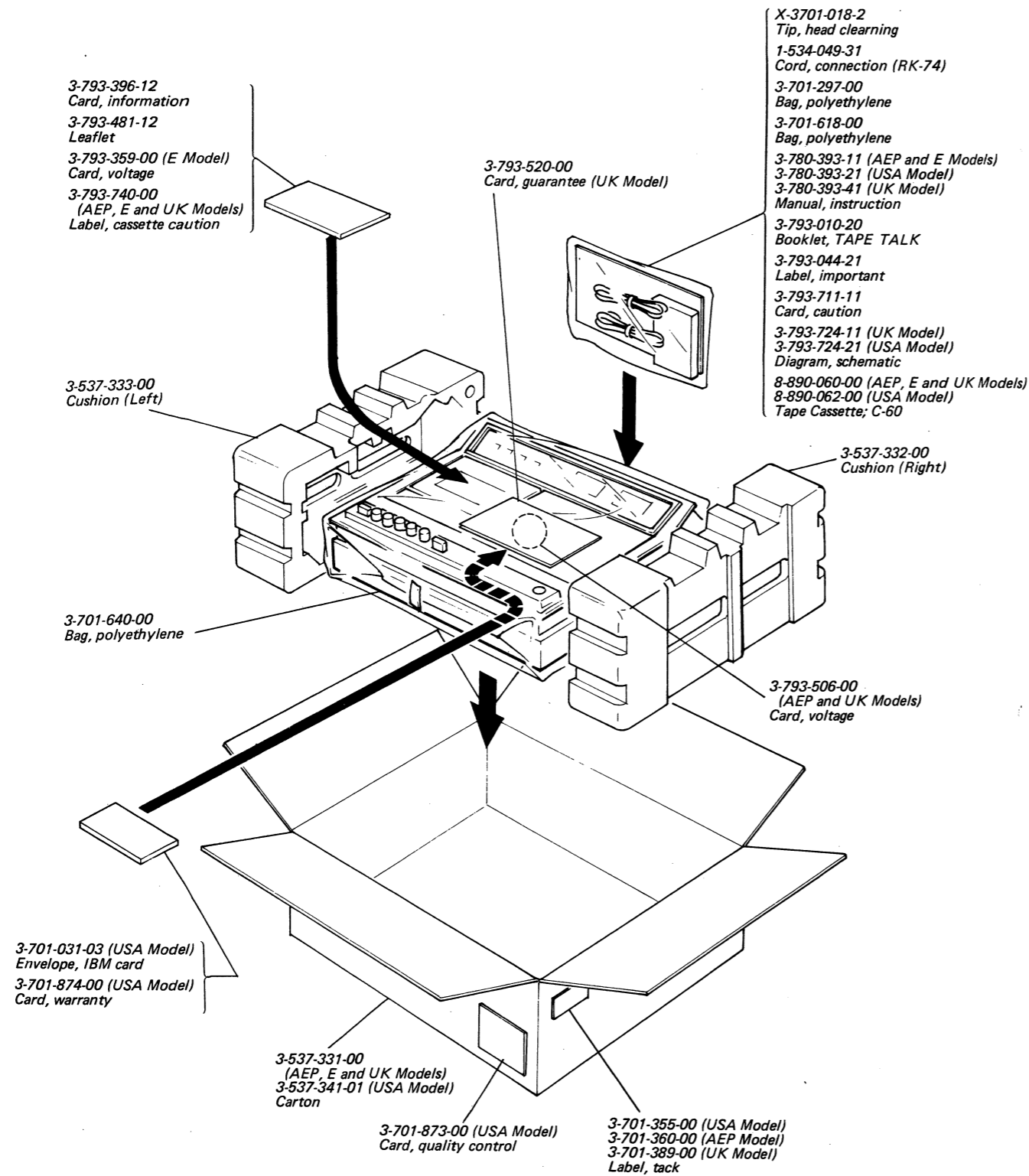

Note:

○ Items without part number and description are not available.

Ref. No.	Part No.	Description	Ref. No.	Part No.	Description
COMPLETE CIRCUIT BOARDS					
A-2025-006-A	LINE IN/LINE OUT/REC PB Jack (AEP, E and UK Models)	Q307, 407	Transistor	2SC633A	
A-2006-002-A	Audio Amp	Q308, 408	Transistor	2SC945	
A-2012-006-A	Audio Amp Power Supply	Q501	Transistor	2SC633A	
A-2014-002-A	Bias Osc	Q502	Transistor	2SC633A	
A-2027-001-A	LINE OUT Control	Q503	Transistor	2SC1475	
		Q504	Transistor	2SC633A	
		Q505	Transistor	2SC633A	
A-2023-022-A	EQ (EQUALIZER) Switch	Q601	Transistor	2SC634A	
A-2027-002-A	Record Control	Q602	Transistor	2SC634A	
A-2027-003-A	REC CAL Control	Q603	Transistor	2SC634A	
A-2023-013-A	BIAS Switch	Q604	Transistor	2SC634A	
		Q605	Transistor	2SC1475	
A-2023-014-A	HEADPHONE/LEVEL Switch	Q606	Transistor	2SC634A	
A-2023-015-A	Timing Switch	Q607	Transistor	2SC634A	
A-2023-016-A	LIMITER Switch	Q608	Transistor	2SC1061	
A-2023-017-A	MONITOR Switch	Q609	Transistor	2SC634A	
A-2023-018-A	DOLBY NR Switch (A)	Q610	Transistor	2SC634A	
A-2023-019-A	DOLBY NR Switch (B)	Q611	Transistor	2SC634A	
A-2019-003-A	System Control	Q612	Transistor	2SC1061	
A-2012-008-A	System Control Power Supply	Q613	Transistor	2SC634A	
A-2019-004-A	Hall IC	Q614	Transistor	2SC634A	
A-2025-013-A	LINE IN/LINE OUT Jack (USA Model)	Q615	Transistor	2SC634A	
		Q616	Transistor	2SC1061	
PRINTED CIRCUIT BOARDS					
1-582-999-00	Light Emitting Diode	D101, 201	Diode	1T22A	
1-582-998-00	Lamp Terminal	D102, 202	Diode	1T22A	
1-582-997-00	Head Terminal	D103, 203	Diode	1S1555	
		D104, 204	Diode	1S1555	
		D105, 205	Diode	1T22A	
SEMICONDUCTORS					
Q101, 201	Transistor	2SK43			
Q102, 202	Transistor	2SC632A	D301, 401	Diode	VO-6C
Q103, 203	Transistor	2SC632A	D302, 402	Diode	1S1555
Q104, 204	Transistor	2SC632A	D303, 403	Diode	1T22A
Q105, 205	Transistor	2SC633A	D304, 404	Diode	1T22A
			D305, 405	Diode	1S1555
Q106, 206	Transistor	2SC633A			
Q107, 207	Transistor	2SC633A	D306, 406	Diode	1S1555
Q108, 208	Transistor	2SC632A	D307, 407	Diode	1S1555
Q109, 209	Transistor	2SC633A			
Q110, 210	Transistor	2SC633A	D501	Diode	SIB01-02
			D502	Diode	SIB01-02
			D503	Diode	SLP24B
Q301, 401	Transistor	2SC633A			
Q302, 402	Transistor	2SC632A	D601	Diode	1T40
Q303, 403	Transistor	2SC633A	D602	Diode	1T40
Q304, 404	Transistor	2SC633A	D603	Diode	1T40
Q305, 405	Transistor	2SC633A	D604	Diode	1T40
Q306, 406	Transistor	2SC633A			

<u>Ref. No.</u>	<u>Part No.</u>	<u>Description</u>	
D605		Diode	1T40
D606		Diode	1T40
D607		Diode	SIB01-02
D608		Diode	1T40
D609		Diode	1T40
D610		Diode	1T40
D611		Diode	1T40
D612		Diode	MZ-08
D613		Diode	SIB01-02
D614		Diode	SIB01-02
D615		Diode	MZ-12
D616		Diode	U05E
D617		Diode	U05E
D618		Diode	U05E
D619		Diode	U05E
IC101, 201		Integrated Circuit, TA7122AP	
IC301, 401		Integrated Circuit, TA7122AP	
IC302, 402		Integrated Circuit, TA7122AP	
IC303, 403		Integrated Circuit, TA7122AP	
IC304, 404		Integrated Circuit, TA7122AP	
IC601		Hall IC, CX-722	

COILS

L101, 201	1-407-240-00	22 mH, variable inductor
L301, 401	1-407-519-00	8 μ H, inductor
L302, 402	1-407-510-00	33 mH, micro inductor
L303, 403	1-407-496-00	2.2 mH, micro inductor
L304, 404	1-407-488-00	0.47 mH, micro inductor
L305, 405	1-407-489-00	0.56 mH, micro inductor

TRANSFORMERS

T1	1-442-329-00	Power (AEP and UK Models)
	1-442-341-00	Power (USA Model)
	1-442-354-00	Power (E Model)
T101, 201	1-427-270-00	Headphone

CAPACITORS

All capacitors are in μ F, unless otherwise indicated. (p = μ m, elect = electrolytic)

C101, 201	1-121-352-11	47	10V	elect
C102, 202	1-107-089-11	150p	50V	silvered mica
C103, 203	1-121-422-11	220	25V	elect
C104, 204	1-107-085-11	100p	50V	silvered mica
C105, 205	1-121-414-11	100	10V	elect
C106, 206	1-105-821-12	0.001	50V	mylar
C107, 207	1-107-085-11	100p	50V	silvered mica
C108, 208	1-121-404-11	33	25V	elect
C109, 209	1-121-392-11	3.3	25V	elect

<u>Ref. No.</u>	<u>Part No.</u>	<u>Description</u>		
C110, 210	1-105-674-12	0.012	50V	mylar
C111, 211	1-107-085-11	100p	50V	silvered mica
C112, 212	1-105-501-12	0.001	50V	mylar
C113, 213	1-121-422-11	220	25V	elect
C114, 214	1-121-450-11	2.2	50V	elect
C115, 215	1-105-821-12	0.001	50V	mylar
C116, 216	1-121-414-11	100p	10V	elect
C117, 217	1-107-073-11	33p	50V	silvered mica
C118, 218	1-121-391-11	1	50V	elect
C119, 219	1-129-701-21	0.01	100V	polypropylene
C120, 220	1-129-896-21	0.012	100V	polypropylene
C121, 221	1-129-899-11	0.056	100V	polypropylene
C122, 222	1-105-510-12	0.0056	50V	mylar
C123, 223	1-121-416-11	100	25V	elect
C124, 224	1-121-422-11	220	25V	elect
C125, 225	1-105-821-12	0.001	50V	mylar
C126, 226	1-107-063-11	12p	50V	silvered mica
C127, 227	1-121-402-11	33	10V	elect
C128, 228	1-105-529-12	0.033	50V	mylar
C129, 229	1-121-392-11	3.3	25V	elect
C130, 230	1-131-197-21	3.3	16V	tan talum
C131, 231	1-121-391-11	1	50V	elect
C132, 232	1-121-669-11	0.0047	50V	elect
C133, 233	1-121-391-11	1	50V	elect
C134, 234	1-121-398-11	10	25V	elect
C135, 235	1-121-391-11	1	50V	elect
C301, 401	1-121-416-11	100	25V	elect
C302, 402	1-131-197-11	3.3	16V	tan talum
C303, 403	1-107-085-11	100p	50V	silvered mica
C304, 404	1-105-821-12	0.001	50V	mylar
C305, 405	1-121-402-11	33	10V	elect
C306, 406	1-107-095-11	270p	10V	silvered mica
C307, 407	1-121-398-11	10	25V	elect
C308, 408	1-121-392-11	3.3	25V	elect
C309, 409	1-121-422-11	220	25V	elect
C310, 410	1-131-236-11	1	25V	tan talum
C311, 411	1-105-821-12	0.001	50V	mylar
C312, 412	1-121-402-11	33	10V	elect
C313, 413	1-121-414-11	100	10V	elect
C314, 414	1-107-079-11	56p	10V	silvered mica
C315, 415	1-121-392-11	3.3	25V	elect
C316, 416	1-121-398-11	10	25V	elect
C317, 417				
C318, 418	1-121-404-11	33	25V	elect
C319, 419	1-121-391-11	1	50V	elect
C320, 420				

<u>Ref. No.</u>	<u>Part No.</u>	<u>Description</u>		
C321, 421	1-131-238-11	10	50V	tantalum
C322, 422	1-129-701-21	0.01	100V	polypropylene
C323, 423	1-129-896-21	0.012	100V	polypropylene
C324, 424	1-129-899-11	0.056	100V	polypropylene
C325, 425	1-105-821-12	0.056	50V	mylar
C326, 426	1-105-821-12	0.001	50V	mylar
C327, 427	1-107-063-11	12p	50V	silvered mica
C328, 428	1-121-402-11	33	10V	elect
C329, 429	1-105-519-11	0.033	50V	mylar
C330, 430	1-121-392-11	3.3	25V	silvered mica
C331, 431	1-131-197-21	3.3	16V	tantalum
C332, 432	1-121-391-11	1	50V	elect
C333, 433	1-105-669-12	0.0047	50V	mylar
C334, 434	1-121-391-11	1	50V	elect
C335, 435	1-105-821-12	0.001	50V	mylar
C336, 436	1-107-081-11	68p	50V	silvered mica
C337, 437	1-121-414-11	100	10V	elect
C338, 438	1-121-398-11	10	25V	elect
C339, 439	1-121-392-11	3.3	25V	elect
C340, 440	1-105-661-12	0.001	50V	mylar
C341, 441	1-107-091-11	180p	50V	silvered mica
C342, 442	1-121-398-11	10	25V	elect
C343, 443	1-107-063-11	12p	50V	silvered mica
C344, 444	1-107-063-11	12p	50V	silvered mica
C345, 445	1-121-402-11	33	10V	elect
C346, 446	1-121-414-11	10	10V	elect
C347, 447	1-107-101-11	4p	50V	silvered mica
C348, 448	1-121-398-11	10	25V	elect
C349, 449				
C350, 450	1-131-211-21	0.2	35V	tantalum
C351, 451	1-107-097-11	330p	35V	silvered mica
C352, 452	1-107-036-11	68p	500V	silvered mica
C353, 453	1-105-521-12	0.047	50V	mylar 5%
C354, 454	1-105-523-12	0.068	50V	mylar 5%
C355, 455	1-105-525-12	0.1	50V	mylar 5%
C356, 456	1-141-034-00	20 ~ 120p		trimmer
C357, 457	1-105-821-12	0.001	50V	mylar
C358, 458	1-131-211-11	0.22	35V	tantalum
C501, 502	1-121-657-11	1000	25V	elect
C503	1-121-417-11	100	50V	elect
C504	1-121-810-11	470	50V	elect
C505	1-117-103-11	1 + 0.5	300V	metalized paper
C506	1-121-450-11	2.2	50V	elect
C507	1-121-416-11	100	25V	elect
C508	1-121-398-11	10	25V	elect

<u>Ref. No.</u>	<u>Part No.</u>	<u>Description</u>		
C509	1-105-680-12	0.039	50V	mylar
C510	1-121-416-11	100	25V	elect
C511 ~ 513	1-105-517-12	0.022	50V	mylar 5%
C514	1-121-398-11	10	25V	elect
C515	1-121-416-11	100	25V	elect
C516, 517	1-121-391-11	1	50V	elect
C519	1-105-678-12	0.027	50V	mylar (AEP, E and UK Models)
C601	1-121-352-11	47	10V	elect
C602	1-121-404-11	33	25V	elect
C603	1-121-419-11	220	6.3V	elect
C604	1-105-673-12	0.01	50V	mylar
C605	1-121-395-11	4.7	25V	elect
C606	1-131-232-11	4.7	16V	tantalum
C607	1-121-391-11	1	50V	elect
C608	1-121-404-11	33	25V	elect
C609	1-121-391-11	1	50V	elect
C610	1-131-199-11	10	16V	tantalum
C611	1-121-396-11	4.7	50V	elect
C612	1-121-395-11	47	25V	elect
C613	1-121-152-11	22	25V	elect
C614	1-121-405-11	33	50V	elect
C615	1-121-416-11	100	25V	elect
C616	1-121-395-11	4.7	25V	elect
C617 ~ 620	1-121-657-11	1000	25V	elect

RESISTORS

All resistors are in Ω , $\frac{1}{4}$ W and carbon type unless otherwise indicated. (k = 1,000, M = 1,000 k)

R101, 201	1-242-697-11	10k
R102, 202	1-242-692-09	6.2k, low noise
R103, 203	1-242-701-09	15k, low noise
R104, 204	1-242-647-11	82
R105, 205	1-242-745-09	1M, low noise
R106, 206	1-242-737-09	470k, low noise
R107, 207	1-242-681-11	2.2k
R108, 208	1-242-698-11	11k
R109, 209	1-242-699-11	12k
R110, 210	1-242-708-09	30k, low noise
R111, 211	1-242-697-09	10k, low noise
R112, 212	1-242-675-09	1.2k, low noise
R113, 213	1-242-681-11	2.2k
R114, 214	1-242-737-09	470, low noise
R115, 215	1-221-630-00	20k, adjustable

<u>Ref. No.</u>	<u>Part No.</u>	<u>Description</u>		<u>Ref. No.</u>	<u>Part No.</u>	<u>Description</u>	
R116, 216	1-221-383-00	10 k, adjustable		R161, 261	1-224-426-00	20 k (A), variable; 2-gang; VOL	
R117, 217	1-242-679-11	1.8 k		R162, 262	1-244-685-11	3.3 k	
R118, 218	1-221-311-00	5 k, adjustable		R163, 263	1-221-311-00	5 k, adjustable	
R119, 219	1-242-685-11	3.3 k		R164, 264	1-244-629-11	15	
R120, 220	1-242-703-11	18 k		R165, 265	1-244-693-11	6.8 k (AEP, E and UK Models)	
R121, 221	1-242-669-11	680		R301, 401	1-242-697-11	10 k	
R122, 222	1-242-717-09	68 k, low noise		R302, 402	1-244-720-11	91 k	
R123, 223	1-242-721-09	100 k, low noise		R303, 403	1-242-709-09	33 k, low noise	
R124, 224	1-242-653-11	150		R304, 404	1-242-727-09	180 k, low noise	
R125, 225	1-242-649-11	100		R305, 405	1-242-697-11	10 k	
R126, 226	1-242-655-11	180		R306, 406	1-242-685-11	3.3 k	
R127, 227	1-242-681-11	2.2 k		R307, 407	1-242-703-11	18 k	
R128, 228	1-210-873-11	430	2%	R308, 408	1-242-697-09	10 k, low noise	
R129, 229	1-210-876-11	4.7 k	2%	R309, 409	1-244-706-11	24 k	
R130, 230	1-242-735-09	390 k, low noise		R310, 410	1-224-425-00	20k (A), variable; MIC VOL (L), (R)	
R131, 231	1-242-737-09	470 k, low noise		R311, 411	1-224-425-00	20k (A), variable; LINE VOL (L), (R)	
R132, 232	1-242-665-11	470		R312, 412	1-242-657-11	220	
R133, 233	1-242-653-11	150		R313, 413	1-242-721-09	100 k, low noise	
R134, 234	1-242-863-11	6.8 k		R314, 414	1-242-721-09	100 k, low noise	
R135, 235	1-242-641-11	47		R315, 415	1-242-653-11	150	
R136, 236	1-242-727-09	180 k, low noise		R316, 416	1-242-567-11	220	
R137, 237	1-242-697-09	10 k, low noise		R317, 417	1-242-653-11	150	
R138, 238	1-242-681-11	2.2 k		R318, 418	1-242-683-11	2.7 k	
R139, 239	1-242-669-11	680		R319, 419	1-210-875-11	3.3 k	2%
R140, 240	1-242-721-09	100 k, low noise		R320, 420			
R141, 241	1-242-729-09	220 k, low noise		R321, 421	1-210-711-11	39 k	
R142, 242	1-242-661-11	330		R322, 422	1-210-709-11	33 k	
R143, 243	1-210-862-11	2.2 k		R323, 423	1-210-677-11	1.5 k	
R144, 244	1-242-693-11	6.8 k		R324, 424	1-210-681-11	2.2 k	
R145, 245	1-210-861-11	220		R325, 425	1-210-665-11	470	
R146, 246	1-242-705-11	22 k		R326, 426	1-210-877-11	8.2 k	2%
R147, 247	1-222-775-00	22 k, adjustable		R327, 427	1-210-874-11	1.2 k	2%
R148, 248	1-242-637-11	33		R328, 428	1-242-681-11	2.2 k	
R149, 249	1-242-695-11	8.2 k		R329, 429	1-242-693-11	6.8 k	
R150, 250	1-242-601-11	1		R330, 430	1-242-723-09	120 k, low noise	
R151, 251	1-242-723-11	120 k		R331, 431	1-242-720-09	91 k, low noise	
R152, 252	1-242-727-11	180		R332, 432	1-242-697-11	10 k	
R153, 253	1-242-719-11	82 k		R333, 433	1-242-697-09	10 k, low noise	
R154, 254	1-242-727-11	180 k		R334, 434	1-242-691-11	5.6 k	
R155, 255	1-242-697-11	10 k		R335, 435	1-242-737-09	470 k, low noise	
R156, 256	1-242-735-11	390 k		R336, 436			
R157, 257	1-242-731-11	270 k		R337, 437	1-242-653-11	150	
R158, 258	1-242-677-11	1.5 k		R338, 438	1-210-853-11	6.2 k	
R159, 259	1-242-667-11	560		R339, 439	1-242-641-11	47	
R160, 260	1-244-681-11	2.2 k		R340, 440	1-242-721-09	100 k, low noise	
				R341, 441	1-242-729-09	220 k, low noise	

TC-177SD

<u>Ref. No.</u>	<u>Part No.</u>	<u>Description</u>	<u>Ref. No.</u>	<u>Part No.</u>	<u>Description</u>
R342, 442	1-242-661-11	330	R502	1-242-617-11	4.7
R343, 443	1-210-862-11	2.2 k	R503	1-242-721-11	100 k
R344, 444	1-242-693-11	6.8 k	R504	1-242-657-11	220
R345, 445	1-210-861-11	220	R505	1-244-877-11	1.5 k
R346, 446	1-242-707-11	27 k	R506	1-242-649-11	100 (USA Model)
R347, 447	1-222-775-00	22 k, adjustable	R506	1-244-849-11	100 ½ W (AEP, E and UK Models)
R348, 448	1-242-637-11	33	R507	1-242-696-11	9.1 k 2%
R349, 449	1-242-695-11	8.2 k	R508	1-210-868-11	12 k 2%
R350, 450	1-242-601-11	1	R509	1-210-878-11	22 k 2%
R351, 451	1-242-723-11	120 k	R510	1-210-875-11	3.3 k 2%
R352, 452	1-242-727-11	180 k	R511	1-244-849-11	100 ½ W
R353, 453	1-242-719-11	82 k	R512	1-210-875-11	3.3 k 2%
R354, 454	1-242-727-11	180 k	R513	1-242-705-11	22 k
R355, 455	1-242-721-09	100 k, low noise	R514	1-242-695-11	8.2 k
R356, 456	1-242-729-09	220 k, low noise	R515	1-242-693-11	6.8 k
R357, 457	1-242-673-11	1 k	R516	1-242-697-11	10 k
R358, 458	1-242-703-11	18 k	R517	1-242-713-11	47 k
R359, 459	1-242-697-11	10 k	R518	1-242-707-11	27 k
R360, 460	1-242-667-11	560	R519	1-242-680-11	2 k
R361, 461	1-222-771-00	1 k, adjustable	R520	1-242-677-11	1.5 k
R362, 462	1-242-705-11	22 k	R521	1-242-637-11	33
R363, 463	1-242-733-11	330 k	R522	1-242-649-11	100
R364, 464	1-224-424-00	20k (B), variable; REC CAL VOL (L), (R)	R523	1-222-775-00	22 k, adjustable
R365, 465	1-242-685-11	3.3 k	R524	1-242-709-11	33 k
R366, 466	1-242-673-11	1 k	R525	1-242-657-11	220
R367, 467	1-242-716-11	62 k	R601	1-242-683-11	2.7 k
R368, 468	1-242-713-11	47 k	R602	1-242-703-11	18 k
R369, 469	1-242-721-09	100 k, low noise	R603	1-242-681-11	2.2 k
R370, 470	1-242-729-09	220 k, low noise	R604	1-242-637-11	33
R371, 471	1-242-661-11	330	R605	1-242-705-11	22 k
R372, 472	1-242-713-11	47 k	R606	1-242-709-11	33 k
R373, 473	1-242-641-11	47	R607	1-242-705-11	22 k
R374, 474	1-242-691-11	5.6 k	R608	1-242-701-11	15 k
R375, 475	1-242-643-11	56	R609	1-242-681-11	2.2 k
R376, 476	1-242-680-11	2 k	R610	1-242-705-11	22 k
R377, 477	1-242-629-11	15 k	R611	1-242-713-11	47 k
R378, 478	1-242-709-11	33 k	R612	1-242-691-11	5.6 k
R379, 479	1-242-679-11	1.8 k	R613	1-242-721-11	100 k
R380, 480	1-242-707-11	27 k	R614, 615	1-242-715-11	56 k
R381, 481	1-242-677-11	1.5 k	R616	1-242-699-11	12 k
R382, 482	1-242-702-11	16 k	R617	1-242-697-11	10
R383, 483	1-242-699-11	12 k	R618	1-242-691-11	5.6 k
R384, 484	1-244-683-11	2.7 k (USA Model)	R619	1-242-719-11	82 k
R384, 484	1-244-691-11	5.6 k (AEP, E and UK Models)	R620	1-242-675-11	1.2 k
R385, 485	1-242-715-11	56 k	R621	1-206-439-11	1 metal oxide
R386, 486	1-242-649-11	100	R622	1-242-701-11	15 k
R501	1-242-697-11	10 k	R623	1-242-715-11	56 k

<u>Ref. No.</u>	<u>Part No.</u>	<u>Description</u>
R624	1-242-709-11	33 k
R625	1-242-721-11	100 k
R626	1-242-701-11	15 k
R627	1-242-625-11	10
R628	1-242-709-11	33 k
R629	1-242-705-11	22 k
R630	1-244-865-11	470
R631	1-242-713-11	47 k
R632	1-242-721-11	100 k
R633	1-242-613-11	3.3
R634	1-242-685-11	3.3 k
R635	1-206-439-11	1 metal oxide
R636	1-242-639-11	39
R637	1-242-691-11	5.6 k
R638	1-242-689-11	4.7 k
R639	1-242-641-11	47
R640	1-242-721-11	100 k
R641	1-242-625-11	10
R642	1-242-687-11	3.9 k
R643	1-242-639-11	39
R644	1-242-709-11	33 k
R645	1-242-685-11	3.3 k
R646	1-244-699-11	12 k
R647	1-242-697-11	10 k
R648	1-244-649-11	100

SWITCHES

S1	1-516-481-00	Lever,Slide, MONITOR
S2	1-514-978-21	Slide, record/playback
S3	1-513-273-00	Slide, timing
S4	1-514-448-00	Slide, HEADPHONE LEVEL
S5	1-516-181-00	Push, POWER (E and USA Models)
	1-516-277-00	Push, POWER (AEP and UK Models)
S6	1-514-655-00	Rocker, 50 Hz-60 Hz change-over (E Model)
	1-514-472-00	Rocker, 50 Hz-60 Hz change-over (AEP and UK Models)
S7	1-516-591-00	Push, FILTER
S8	1-516-483-00	Push, LIMITER
S9	1-514-722-00	Micro, PAUSE (1)
S10	1-516-591-00	Push, DOLBY NR
S11	1-516-591-00	Push, CAL TONE
S12	1-516-482-00	Lever-slide, TAPE SELECT; BIAS
S13	1-516-482-00	Lever-slide, TAPE SELECT; EQ
S14	1-516-591-00	Push, FM DOLBY NR
S601	1-514-722-00	Micro, solenoid

<u>Ref. No.</u>	<u>Part No.</u>	<u>Description</u>
S602	—	Leaf, counter; included in tape counter
S603	1-516-133-00	Slide, MEMORY COUNTER
S604	1-514-880-00	Leaf, rewind
S605	1-516-134-00	Leaf, PAUSE (2)
S606	1-514-722-00	Micro, transient
S607	1-514-722-00	Micro, function
S608	1-514-722-00	Micro, cassette

JACKS

CNJ101	1-507-433-00	4 p, LINE IN/LINE OUT
CNJ201		
CNJ301		
CNJ401		
CNJ501	1-509-549-00	Connector, REC/PB (AEP, E and UK Models)
J301, 401	1-507-282-00	Phone, MICROPHONE L, R; JM-60, M-21
J502	1-507-376-00	Binaural, HEADPHONE; JM-60, M-15

MISCELLANEOUS

CP1	1-231-057-31	Encapsulated Component, C-R; 0.033 μ F + 120 Ω , 500 V
CP2	8-742-520-00	Module, power supply BX-252
CP3	1-464-038-00	Pack, bias osc
F	1-532-133-00	Fuse, 0.63 A (E Model)
F1	1-532-235-00	Fuse, 315 mA (AEP and UK Models)
F2, 5	1-532-063-00	Fuse, 1 A (AEP and UK Models)
F3, 4	1-532-074-00	Fuse, 200 mA (AEP and UK Models)
F6	1-532-205-00	Fuse, 200 mA (AEP and UK Models)
LPF301	1-231-219-00	Unit, low-pass filter
LPF401		
EH501	8-825-624-00	Head, erase; EF157-36
M	8-831-526-00	Motor, HC-526
ME101	1-520-187-00	Meter, VU
ME201		
PH201	8-825-623-00	Head, playback; PF145-3602B
PL3 ~ 8	1-518-114-xx	Lamp
PM1	1-454-122-00	Solenoid, function
PM2	1-454-123-00	Solenoid, stop
RH301	8-824-801-00	Head, record; RF155-6102
	1-533-102-00	Holder, fuse (E Model)
	1-533-125-00	Holder, fuse (AEP and UK Models)
	1-534-487-00	Cord, power (E Model)
	1-534-538-21	Cord, power (USA Model)
	1-535-506-00	Terminal, crimping
	1-536-395-00	Terminal Strip, 1L1
VS	1-509-427-00	Voltage Selector (E Model)
	1-509-482-00	Socket, voltage selector (AEP and UK Models)
J601	1-509-546-00	Connector, 3 p; AC IN (AEP and UK Models)

**SECTION 7
HARDWARE**

<u>Part No.</u>	<u>Description</u>	<u>Part No.</u>	<u>Description</u>
SCREWS			
All screws are Phillips type (cross recess type) unless otherwise indicated. (-); slotted head.			
7-621-255-34	PS 2.6 x 5	7-682-127-01	P 2 x 8
7-621-259-04	PSW 2.6 x 5	7-682-129-01	P 2 x 10
7-621-259-15	P 2.6 x 3	7-682-253-15	PS 2 x 5
7-621-646-02	PS 3 x 5	7-682-651-00	PS 3 x 14
7-621-647-02	PS 3 x 6	7-682-528-01	B 2 x 10
7-621-649-02	PS 3 x 10	7-682-549-01	B 3 x 10
7-621-650-02	PS 3 x 12	7-682-646-00	PS 3 x 5
7-621-710-29	SC 2 x 3; w/hexagon socket	7-682-648-02	P 3 x 8
7-621-259-52	P 2.6 x 8	7-682-947-01	PSW 3 x 6
7-628-253-95	PS 2.6 x 4	7-682-948-00	PSW 3 x 8
7-628-254-05	PS 2.6 x 5	7-682-950-00	PSW 3 x 12
7-682-124-04	P 2 x 4	7-682-951-01	PSW 3 x 4
7-682-125-01	P 2 x 5	7-682-960-01	PSW 4 x 6
		7-683-127-00	⊖ 2 x 4, set (w/cone point)
		7-683-237-01	SC 3 x 3; (w/hexagon socket)
		7-685-132-01	P 2.6 x 5
		7-685-145-21	P 3 x 6, self-tapping

— Hardware Nomenclature —

<p>P — Pan Head Screw </p> <p>PS — Pan Head Screw with Spring Washer </p> <p>K — Flat Countersunk Head Screw </p> <p>B — Binding Head Screw </p> <p>RK — Oval Countersunk Head Screw </p> <p>T — Truss Head Screw </p> <p>R — Round Head Screw </p> <p>F — Flat Fillister Head Screw </p>	<p>SC — Set Screw </p> <p>E — Retaining Ring (E Washer) </p> <p style="margin-left: 40px;">W — Washer</p> <p style="margin-left: 40px;">SW — Spring Washer</p> <p style="margin-left: 40px;">LW — Lock Washer</p> <p style="margin-left: 40px;">N — Nut</p> <p>— Example —</p> <div style="margin-left: 20px;"> </div>
---	---

MEMO

A series of horizontal dotted lines for writing.

TC-177SD